

# **Empirical Study on Indoor Building Solution for GSM Networks**

By

Md. Tanvir Hossain Bappy

**Id: 151-19-1720**

This Internship Report is presented in partial fulfillment of the requirements of the Degree  
of Bachelor of Science in Electronics and Telecommunication Engineering

Supervised By

**Engr. Md. Zahirul Islam**

**Assistant Professor**

**Department of ICE**

**Daffodil International University**



**DAFFODIL INTERNATIONAL UNIVERSITY**

**DHAKA-1207, BANGLADESH**

**January, 2019**



# *Certificate of Training*

## *Industrial attachment on Telecommunication Hardware installation & commissioning (3 Months)*

*This is to certify that*

*Md. Tanvir Hossain Son of Md. Golam Mostafa*

*Under Internship ID : SLI\_0014*

*Successfully completed the above course .*

Signed: .....

**Abu Sayed Hero**  
**Managing Director**  
**Starlink Engineering Limited**



### **STARLINK ENGINEERING LTD**

Registered office: GA 63, Mohakhali School Road, Banani, Dhaka-1212, Phone: 02-9898316

E-mail: info@starlinkbd.com, web: www.starlinkbd.com

## APPROVAL

This Internship Report Titled “**Empirical Study on In Building Solution for GSM Networks**” is submitted by Md. Tanvir Hossain Bappy to the Department of Information & Communication Engineering, Daffodil International University, has been accepted as fit for the partial fulfillment of the condition for the Degree of BSc (Hon’s) in Electronics & Telecommunication Engineering & approved as to its style and guts. The Presentation will be held on January, 2019

## BOARD OF EXAMINERS

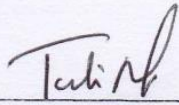

**Md. Taslim Arefin**  
Associate Professor & Head  
Department of ICE  
Daffodil International University

Chairman



**Dr. A. K. M Fazlul Haque**  
Associate Dean & Professor  
Department of ICE  
Daffodil International University

Internal Examiner



**Dr. Engr. Quamruzzaman**  
Professor  
Department of ICE  
Daffodil International University

Internal Examiner

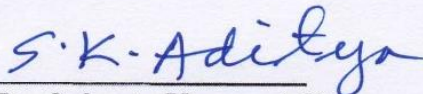

**Dr. Subrata Kumar Aditya**  
Professor  
Department of EEE  
University of Dhaka

External Examiner



## DECLARATION

I hereby declare that this Internship Report has been done by me under the supervision of **Engr. Md. Zahirul Islam**, Assistant Professor, Department of ICE, Daffodil International University & Starlink Engineering Limited. I also declare that neither this report nor any part of it has been submitted away for award of any degree.

### Supervised by



**Engr. Md. Zahirul Islam**

**Assistant Professor**

Department of ICE

Daffodil International University

### Submitted by



**Md. Tanvir Hossain Bappy**

ID: 151-19-1720

Department of ICE

Daffodil International University

## ACKNOWLEDGMENTS

At First, I am like to convey my gratitude to the Almighty for charitable me the right path while trying the duty.

The real sprit of achieving a goal is finished the way of quality and austere castigation. I would have never thrived in effecting my task without the teamwork, help and support provided to me by many personalities.

This internship report would not consume been possible without the provision and direction of **Engr. Md. Zahirul Islam, Assistant Professor**, Department of Information and communication Engineering, Daffodil International University, Dhaka, under whose direction I chose this topic.

I would like to rapid my heartiest gratitude to **Md. Taslim Arefin, Associate Professor and Head**, Department of Information and communication Engineering, for his kind help to surface our thesis and also to other faculty participants, the staffs of the ICE Department of Daffodil International University.

I must grant with due esteem the perpetual support and endurance of my family members for final this internship.

**Md. Tanvir Hossain Bappy**

## ABSTRACT

Communication is the key for any business success; signal coverage is the primary requirement of any communication system. Mobile wireless applications are a good way to increase productivity, improve customer service and streamline business processes. 3G mobile applications, however, bring a unique challenge: ensuring adequate in-building coverage. In Building Solution (IBS) is an indoor signal coverage solution as the extension of the existing mobile network. It distributes the RF signals to different indoor locations via the distributed antenna system, which consists of antenna, power splitter, coupler etc, and improves wireless coverage inside buildings to capture indoor traffic volumes and revenue streams, which would otherwise be lost. In this report contains the technical description of IBS for the full turnkey mobile telecommunication system design, describing an in-building solution that supports GSM1800 services in the **Election commission building** and **Obontika colortex an election commission building an election commission building**. The report also provides information on the network architecture, its design criteria and assumptions, equipment description, including issues on capacity and dimensioning, frequency planning, system interference and spillage control.

# TABLE OF CONTENT

<b>Chapter</b>	<b>Page</b>
<b>Chapter 1: Introduction</b>	1-3
1.1 Introduction	1
1.2 About Starlink Engineering Limited	1-2
1.3 Company profile	2
1.4 Objective of the Report	2
1.5 Methodology	3
1.6 Summary of the Report	3
<b>Chapter 2 Cellular System and GSM Technology</b>	4-12
2.1 GSM system overview	4
2.2 Architecture of the GSM network	4
2.2.1 The Mobile Station	5
2.2.2 The Mobile equipment	6
2.2.3 The SIM	6
2.3 The Base Station Subsystem (BSS)	7
2.3.1 The Base Transceiver Station (BTS)	8
2.3.2 The Base Station Controller (BSC)	9
2.4 The Network and Switching Subsystem (NSS)	10
2.4.1 The Mobile services Switching Center (MSC)	11
2.4.2 The Gateway Mobile Service Switching Center (GMSC)	11
2.4.3 Home Location Register (HLR)	11
2.4.4 Visitor Location Register (VLR)	12
2.4.5 The Authentication Center (AC)	12
2.4.6 The Equipment Identity Register (EIR)	12

<b>Chapter 3 Types of cellular network technologies</b>	13-16
3.1 Introduction	13-14
3.2 Problem Statements	15
3.3 Project Objectives	16
<b>Chapter 4 Types of cellular network technologies</b>	17-18
4.1 What is an In-Building Solution & Why is it required?	17
4.2 Network Problems inside Buildings	17
4.3 General RF Requirements of a customer	18
<b>Chapter 5 Indoor building solution site survey</b>	19-28
5.1 Introduction	19
5.2 Important	19
5.3 What Type of site survey elements	19
5.4 Physical building survey	19
5.4.1 Required data:	20-21
5.5 Internal building propagation loss	22
5.5.1 Test procedure	23
5.5.2 Required equipment	24
5.6 External building propagation loss	25
5.6.1 Test procedure	25-26
5.6.2 Required equipment	27
5.7 In building solution proposal	27-28
<b>Chapter 6 Installation of BTS 3900/3900L/3900A (includes the following activities)</b>	29-50
6.1 HUAWEI BTS 6900/6900L/6900A	29
6.2 Position in the System	29
6.3 Site Requirements	30
6.4 Site Engineer Requirements	30
6.5 BTS 6900/6900L/6900A configuration	31
6.6 BTS Components	31
6.6.1 MRFU – Multicarrier Radio Frequency Unit	32



6.6.2 BBU – Base Band Unit	32
6.6.3 FAN	32
6.6.4 DCDU - DC Distribution Unit	33
6.7 Typical configuration of MRFU	34-35
6.8 GP SWAP WORK FLOW	36
6.9 Pre-swap activities	37
6.9.1 EMU- Environment Monitoring Unit	37
6.9.2 Placing Huawei DDF	38-39
6.9.3 Temperature Sensor	39
6.9.4 Connector making:	39-42
6.10 GP Swap activities	43
6.10.1 E1 and 12 pair alarm cable connection	44
6.10.2 Installing base plate and BTS	45
6.10.3 Changing circuit breaker	46-47
6.10.4 Jumper cable connection to BTS	48
6.10.5 BTS power	49
6.10.6 E1 connection	50
<b>Chapter 7 Planning of Accessories</b>	51-57
7.1 Distributed Antenna Systems	51-52
7.2 Planning of Accessories Directional or Cell-Max antennas	53
7.2.1 Antenna Gain	54
7.3 Passive Distribution Techniques	54-56
<b>Chapter 8 Planning of Accessories</b>	57-60
8.1 Introduction	57
8.2 RF power and Link Budget	57
8.2.1 The signal strength required	57
8.2.2 BTS Power output	58
8.2.3 Radiated EIRP (Effective Isotropic Power)	58
8.3 Link Budget Element of a GSM Network	58

8.4 Link Budget	59
8.5 Mobile Receiver Sensitivity	60
<b>Chapter 9 Acceptance Testing</b>	61-74
9.1 Materials or Accessories Check	61
9.2 Electrical & Ground Check	61
9.3 RF Signal Check	61
9.4 Antenna and RBS System – Overview	62
9.5 Commissioning part step to step	63-69
9.6 Creating alarm	
9.7 VSWR	72-73
9.8 Call Test	74
9.9 PAT documents	74
<b>Chapter 10 Conclusion</b>	75
10.1 Conclusion	75
<b>References</b>	76

## List of Figures

<b>Figure Name</b>	<b>Page</b>
Fig 2.1 GSM network Architecture	5
Fig 2.2 Mobile Station	5
Fig 2.3 Mobile SIM	7
Fig2.4 BSS Architecture	7
Fig2.5 The Base Transceiver Station (BTS)	8
Fig 2.6 The Base Station Controller (BSC)	9
Fig 2.7 2.7 NSS	10
Fig 6.1 Position of the Base Station within the SBS	29
Fig 6.2 BTS 6900 component	31
Fig 6.3 BTS 6900L component	31
Fig 6.4 Base Band Unit	32
Fig 6.5 FAN	33
Fig 6.6 Single MRFU	
Fig 6.7 Double MRFU	35
Fig 6.8 S4/4/4 and S4/12/8	35
Fig 6.9 Environment Monitoring Unit	
Fig 6.10 TX rack with OVP	38
Fig 6.11 TX rack with Huawei DDF	39
Fig 6.12 Temperature sensor	39
Fig 6.13 connector making tools	40
Fig 6.14 connector making tools	41
Fig 6.15 Connector making	42
Fig 6.16 GP swap work flow (1)	43
Fig 6.17 GP swap work flow (2)	44
Fig 6.18 Fixing the Huawei BTS and install BTS over base	46
Fig 6.19 Changing breaker in Rectifier	47
Fig 6.20 Jumper cable connection	48
Fig 6.21 Power ON and measuring Volta	49

Fig 6.22 Loop test	50
Fig 7.1 Omni Antennas	52
Fig 7.2 Directional or Cell-Max Antennas	53
Fig 7.3 Different Type Splitters	54
Fig7.4 10 dB Coupler	55
Fig 8.1 Link Budget Element of a GSM Network	58
Fig 9.1 Omni Antenna connect to mobile signal (uplink)	62
Fig 9.2 Site management right	64
Fig 9.3 Forced software load for GTMU	64
Fig 9.4 GTMU software activation	65
Fig 9.5 Set site type	65
Fig 9.6 Add cabinet	66
Fig 9.7 Add UBRI from board configuration	66
Fig 9.8 Software load for UBRI	67
Fig 9.9 Software activation for UBRI	67
Fig 9.10 Adding MRFU for 190	68
Fig 9.11 Adding MRFU for 1800	68
Fig 9.12 MRFU software load	69
Fig 9.13 Software activation for MRFU	69
Fig 9.14 creating and removing alarm	72
Fig 9.15 creating and removing alarm	73
Fig 9.16 VSWR on RX	73

## List of Tables

<b>Table name</b>	<b>Page</b>
Table 6.1 Panel of the DCDU	33
Table 6.2 SMS sending procedure of Entry & Exit	36
Table 6.3 E1 color code	44
Table 6.4 GP alarm color code	45
Table 7.1 Antenna Gain	54
Table 7.2 Feeder cable Loss per meter	55
Table 7.3 Different type coupler Loss	56
Table 7.4 Different type Splitter Loss	56
Table 8.1 ACE configuration table	59

# Chapter1

## Introduction

### 1.1 Introduction

**GSM (Global System for Mobile Communications, originally Group Special Mobile)**, is a standard set developed by the European Telecommunications Standards Institute (ETSI) to describe technologies for second generation (or "2G") digital cellular networks. The standard was expanded over time to include first circuit switched data transport, then packet data transport via GPRS. Packet data transmission speeds were later increased via EDGE. The GSM standard is succeeded by the third generation (or "3G") UMTS standard developed by the 3GPP. GSM networks will evolve further as they begin to incorporate fourth generation (or "4G") LTE Advanced standards. "GSM" is a trademark owned by the GSM Association. [8]

Cellular is one of the fastest growing and most demanding telecommunications applications. Today, it represents a continuously increasing percentage of all new telephone subscriptions around the world. A **base transceiver station (BTS)** or **cell site** is a piece of equipment that facilitates wireless communication between user equipment (UE) and a network. UEs are devices like mobile phones (handsets), computers with wireless internet connectivity, WiFi and WiMAX gadgets etc. The BTS is the air interface with mobile phone on move (Subscriber's mobile set) to log on to the network enabling the calling Subscribers to be switched to the called party through BSC & MSC. In order to make the best use of telephone subscription a standard BTS installation process should be followed. In this Internship Report, BTS installation process and Commissioning has been described.

### 1.2 About Starlink Engineering Limited.

Starlink Engineering Limited is an Engineering servicing company providing full scope of engineering services like initial Site Survey, Planning, Installation, Commissioning, Operation and Maintenance as well as network optimization in the field of Telecommunication and Information Technology. Starlink Engineering Limited was started in 2008 by a group of young and passionate Engineering Team to partnership with different vendors, Telecom operators and corporate enterprises in Bangladesh. Starlink Engineering Limited was established in 2008. Company have won many Achievement awards over the years, most recently the 2011



Excellent Development Award in GP Swap Project from the Huawei Technologies (Bangladesh) Ltd. These complement similar awards in 2007, 2009 and 2010.

### **1.3 Company Profile**

**Name** : **Starlink Engineering Limited.**  
**Address** : Flat# A-1, House# 83, Road# 23, Gulshan, Dhaka-1212  
**Telephone** : +88029862208  
**Email** : E-mail: info@starlinkengineering.com  
**Website** : <http://www.starlinkengineering.com>

### **1.4 Objective of the Report**

To work with an organization offering a responsible, challenging and creative work profile, Cope with the real-world environment, gain knowledge in mobile communication through hands on task and use theoretical knowledge in practice successfully where my credentials and technical expertise can be utilized.

#### **GP SWAP: Installation of BTS 3900/3900L/3900A (includes the following activities):**

##### **Indoor Works (Pre-Swap)**

Check materials with proper DN EMU Installation as per layout plan Install Crone box in TX rack PCM cable, alarm cable, power cable, Grounding cable latching Marking the cell and making connectors as per need.

##### **Indoor Works (Swap)**

Alarm punching in Huawei DDF

BTS installation as per layout and changing circuit breaker in Rectifier E1 punching in Huawei DDF to slim rack

Software commissioning and alarm creating for BTS 3900/3900L/3900A Call test and fill up the PAT documents

## **1.5 Methodology**

In preparing this project I have collected data and information from the following sources:

- Primary Data
- Secondary Data

Primary data were collected by informal discussions with the users. The required output documents were analyzed to find out the actual requirements. The prime secondary source was “HUAWEI website”, Google website, Wikipedia and some information was collected from the Internet from various web sites. Preparing this report on my Internship with STARLINK COMMUNICATION Limited, all these primary and secondary data were collected, corrected, organized, analyzed and interpreted to draw some findings.

## **1.6 Summary of the Report**

A description on the GSM network has been made in Chapter 2. The detailed installation process of Base Transceiver Station (BTS) and commissioning has been depicted in Chapter 3. At last in Chapter 4 Conclusion has been given.

## Chapter 2

### Cellular System and GSM Technology.

#### 2.1 GSM system overview

The GSM system is a frequency- and time-division cellular system, each physical channel is characterized by a carrier frequency and a time slot number. Cellular systems are designed to operate with groups of low-power radios spread out over the geographical service area. The area served by each group of radios is called a CELL. Uplink and downlink signals for one user are assigned different frequencies; this kind of technique is called Frequency Division Duplex (FDD). Data for different users is conveyed in time intervals called slots, several slots make up a frame. This kind of technique is called Time Division Multiple Access (TDMA) [2].

#### 2.2 Architecture of the GSM network

The GSM network can be divided into three broad parts. The Mobile Station is carried by the subscriber; the Base Station Subsystem controls the radio link with the Mobile Station. The Network Subsystem, the main part of which is the Mobile services Switching Center, performs the switching of calls between the mobile and other fixed or mobile network users, as well as management of mobile services, such as authentication. Not shown is the Operations and Maintenance center, which oversees the proper operation and setup of the network. The Mobile Station and the Base Station Subsystem communicate across the Um interface, also known as the air interface or radio link. The Base Station Subsystem communicates with the Mobile service Switching Center across the A interface. The GSM technical specifications define the different entities that form the GSM network by defining their functions and interface requirements. [3]

The GSM network can be divided into four main parts:

- The Mobile Station (MS).
- The Base Station Subsystem (BSS).
- The Network and Switching Subsystem (NSS).
- The Operation and Support Subsystem (OSS).

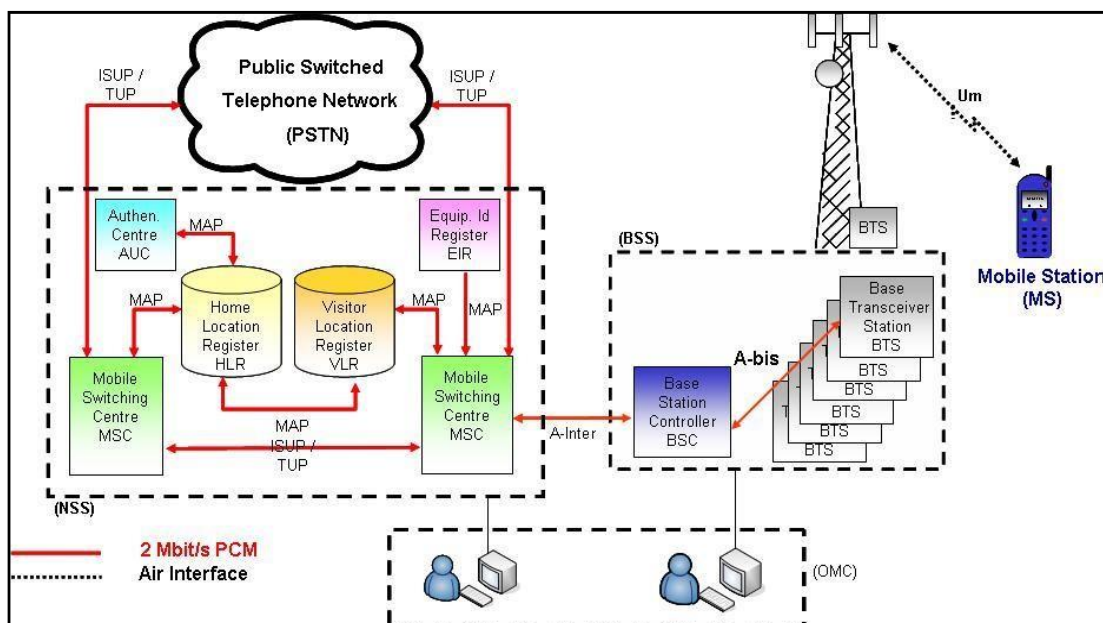

Fig-2.1: GSM network Architecture

## 2.2.1 The Mobile Station

The mobile station represents the mobile network components. They consist of the Mobile Equipment ME and Subscriber Identity Module SIM:  $MS = ME + SIM$

### Mobile Station—MS

$$MS = ME + SIM$$

International Mobile Equipment Identity (IMEI)  
— Mobile Equipment

International Mobile Subscriber Identity (IMSI)  
— Subscriber Identity Module



Fig-2.2: Mobile Station [5]

### **2.2.2 The Mobile equipment**

The mobile equipment ME unites the tasks of many functional element of the fixed GSM-PLMN network. By using the data of the SIM card, the speech is digitalized, compressed, secured against loss of data (redundancy + interleaving), encrypted to prevent interception and modulated onto the Radio Frequency (RF) created by the mobile station. Directly after, the signal is amplified and transmitted. In the opposite direction, the process runs inversely, beginning with the reception of the radio frequency. The MS represent the counterpart to BSC, MSC, HLR, VLR, and EIR as regards signaling. As a whole ME and SIM are almost a complete GSM system as regards their functionality. [3]

### **2.2.3 The SIM**

A subscriber identity module or subscriber identification module (SIM) is an integrated circuit that securely stores the service-subscriber key (IMSI) used to identify a subscriber on mobile telephony devices. The SIM consist of a microchip, which uses either a check card or a plate made of a synthetic material as a carrier. Without an SIM card, the use of an MS is normally not possible. The SIM card carries subscriber-related information and codes, so that a GSM subscriber with a SIM card can use different ME. The main task of the SIM is storage of data. [4]

Important stored codes are:

- Personal Identity number – PIN
- PIN unblocking key – PUK
- Mobile station ISDN number – MSISDN
- International Mobile Subscriber Identity – IMSI
- Temporary Mobile Subscriber Identity – TMSI Important

data related security:

- The individual key – Ki
- The Cipher key – Kc
- The algorithm for authorization and ciphering [3]

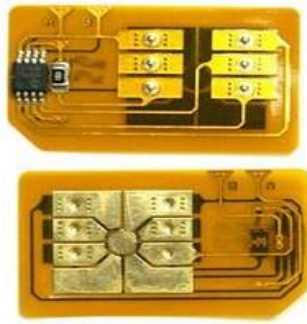

Fig-2.3: Mobile SIM

### 2.3 The Base Station Subsystem (BSS)

The BSS connects the Mobile Station and the NSS. It is in charge of the transmission and reception. The BSS can be divided into: [1]

- The Base Transceiver Station (BTS).
- The Base Station Controller (BSC).
- Transcoding & Rate Adaptation Unit (TRAU) [3]

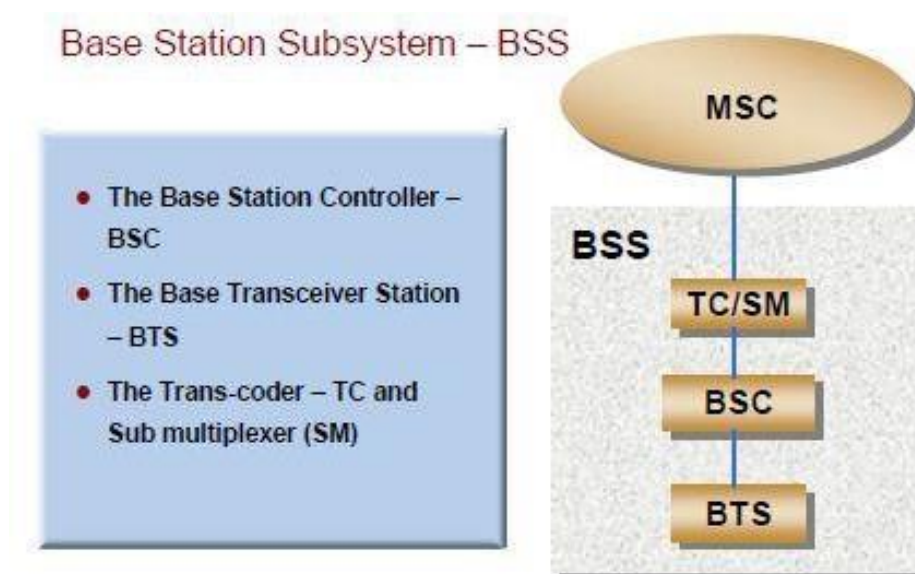

Fig 2.4: BSS Architecture [5]



### 2.3.1 The Base Transceiver Station (BTS)

The Base Transceiver Station (BTS) handles the radio interface to the mobile station. The BTS is the radio equipment (transceivers and antennas) needed to service each cell in the network. A group of base transceiver stations (BTSs) is controlled by a base station controller (BSC). The Base Transceiver Station, or BTS, contains the equipment for transmitting and receiving of radio signals (transceivers), antennas, and equipment for encrypting and decrypting communication with the Base Station Controller (BSC). Typically a BTS for anything other than a Pico cell will have several transceivers (TRXs) which allow it to serve several different frequencies and different sectors of the cell (in the case of sectorised base stations). Even though GSM is a standard, the reality is that the functions of a BTS vary from vendor to vendor. There are vendors in which the BTS is a plain transceiver which receives information from the MS (Mobile Station) through the Um (Air Interface) and then converts it to a TDM ("PCM") based interface, the Abis, and sends it towards the BSC. There are vendors which build their BTSs so the information is preprocessed, target cell lists are generated and even intracell handover (HO) can be fully handled. The advantage in this case is fewer loads on the expensive Abis interface. [3]

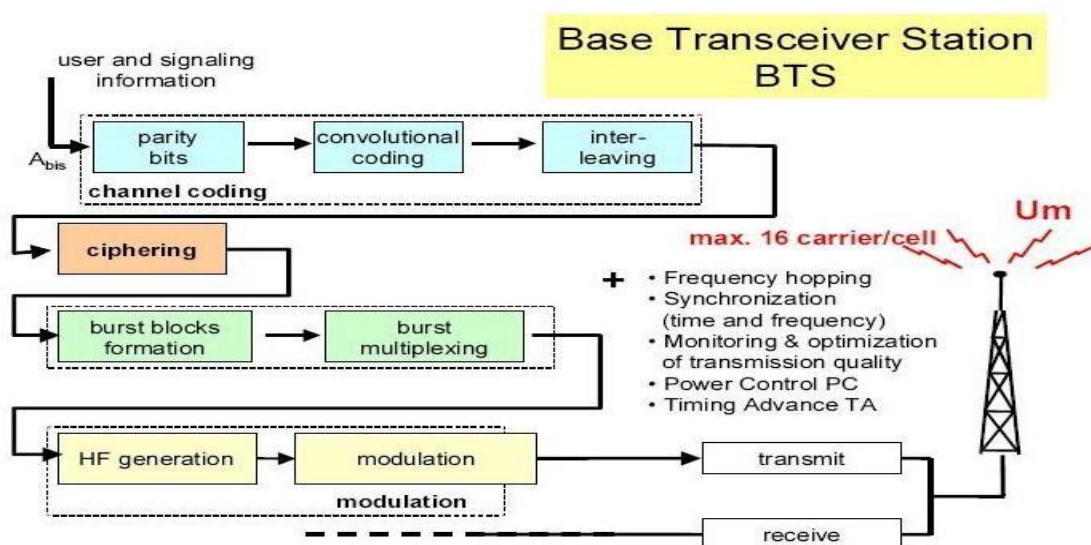

Fig-2.5: The Base Transceiver Station (BTS) [3]

### 2.3.2 The Base Station Controller (BSC)

The Base Station Controller BSC is, as the controlling element, the heart and the center element of the BSS. The BSC handles allocation of radio channels, receives measurements from the mobile phones, and controls handovers from BTS to BTS. BSC Location: between the interfaces A<sub>sub</sub> and A<sub>bis</sub>

BSC Functions:

- Switching of the user traffic between individual TRAU<sub>s</sub> and BTS<sub>s</sub>
- Control and Monitoring of the connected TRAU<sub>s</sub> and BTS<sub>s</sub>
- Sampling of operation and maintenance information of BSC, TRAU<sub>s</sub> and BTS<sub>s</sub>
- Evaluation of signaling information from MSC via TRAU and MS via BTS
- Radio Resource Management for all connected BTS<sub>s</sub>
- Storage of the BSS configuration
- Back-up storage of the total BSS software for first system restart [3]

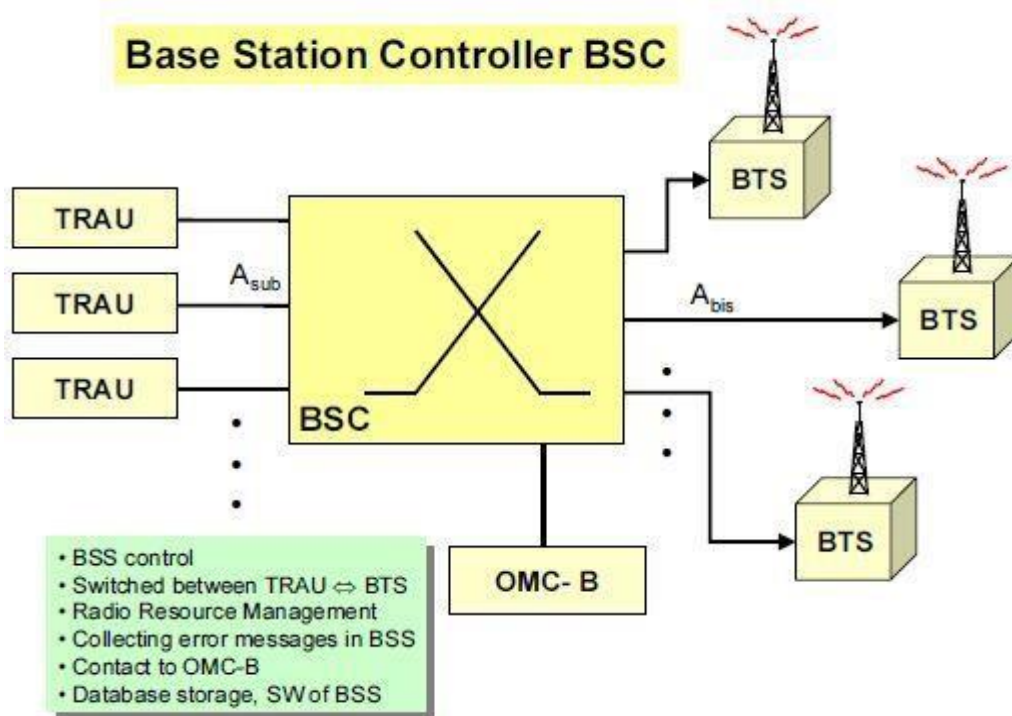

Fig-2.6: The Base Station Controller (BSC)

## 2.4 The Network and Switching Subsystem (NSS)

Network switching subsystem (NSS) (or GSM core network) is the component of a GSM system that carries out call switching and mobility management functions for mobile phones roaming on the network of base stations. It is owned and deployed by mobile phone operators and allows mobile devices to communicate with each other and telephones in the wider Public Switched Telephone Network or (PSTN). The architecture contains specific features and functions which are needed because the phones are not fixed in one location. The NSS originally consisted of the circuit-switched core network, used for traditional GSM services such as voice calls, SMS, and circuit switched data calls. It was extended with an overlay architecture to provide packet-switched data services known as the GPRS core network. This allows mobile phones to have access to services such as WAP, MMS, and the Internet. [6]

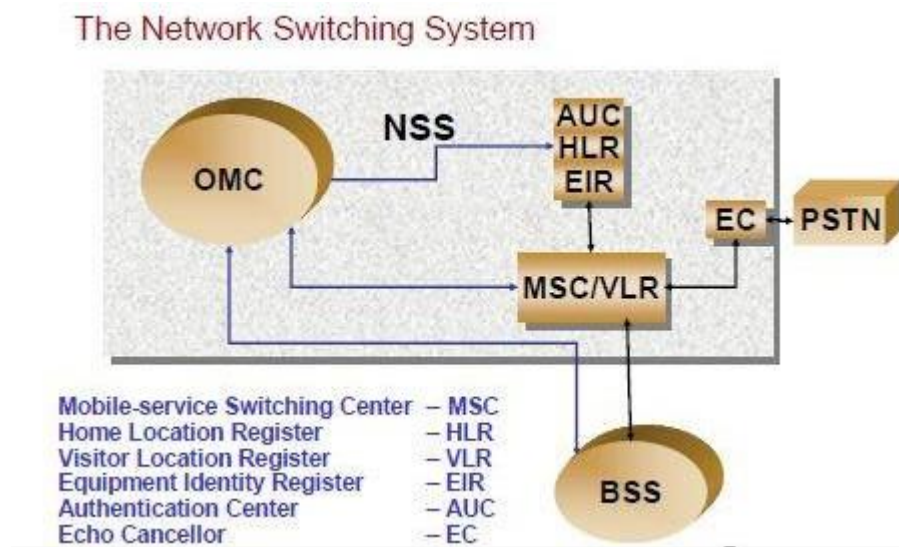

Fig 2.7 NSS [5]

The different components of the NSS are described below [3]

- MSC: Mobile Services Switching Center
- VLR: Visitor Location Register
- HLR: Home Location register
- AC: Authentication Center
- EIR: Equipment Identity Register

### 2.4.1 The Mobile services Switching Center (MSC)

It is the central component of the NSS. The MSC performs the switching functions of the network. It also provides connection to other networks. The MSC is a switching center that carries out all switching for the mobile stations which are actually located in the MSC area.

#### Mobile-service Switching Center – MSC

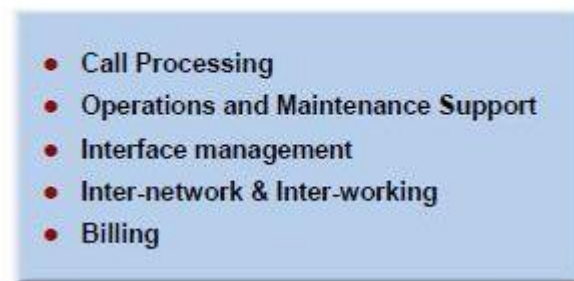

Fig 2.8 Mobile-service Switching Center - MSC

### 2.4.2 The Gateway Mobile Service Switching Center (GMSC)

The **Gateway MSC** (G-MSC) is the MSC that determines which visited MSC the subscriber who is being called is currently located at. It also interfaces with the PSTN. All mobile to mobile calls and PSTN to mobile calls are routed through a G-MSC. The term is only valid in the context of one call since any MSC may provide both the gateway function and the Visited MSC function; however, some manufacturers design dedicated high capacity MSCs which do not have any BSSs connected to them. These MSCs will then be the Gateway MSC for many of the calls they handle. [2]

### 2.4.3 Home Location Register (HLR)

The home location register (HLR) is a central database that contains details of each mobile phone subscriber that is authorized to use the GSM core network. There can be several logical, and physical, HLRs per public land mobile network (PLMN), though one international mobile subscriber identity (IMSI)/MSISDN pair can be associated with only one logical HLR time. The HLRs store details of every SIM card issued by the mobile phone operator. Each SIM has a unique identifier called an IMSI which is the primary key to each HLR record. The HLR is always associated with Authentication Center AC. [2]

#### **2.4.4 Visitor Location Register (VLR)**

The visitor location register is a database of the subscribers who have roamed into the jurisdiction of the MSC (Mobile Switching Center) which it serves. Each base station in the network is served by exactly one VLR; hence a subscriber cannot be present in more than one VLR at a time. The data stored in the VLR has either been received from the HLR, or collected from the MS (Mobile station). In practice, for performance reasons, most vendors integrate the VLR directly to the V-MSC and, where this is not done, the VLR is very tightly linked with the MSC via a proprietary interface. Whenever an MSC detects a new MS in its network, in addition to creating a new record in the VLR, it also updates the HLR of the mobile subscriber, apprising it of the new location of that MS. If VLR data is corrupted it can lead to serious issues with text messaging and call services.

[2] Data stored include:

- IMSI (the subscriber's identity number).
- Authentication data.
- MSISDN (the subscriber's phone number).
- GSM services that the subscriber is allowed to access.
- Access point (GPRS) subscribed.
- The HLR address of the subscriber

#### **2.4.5 The Authentication Center (AC)**

The AC register is used for security purposes. It provides the parameters needed for authentication and encryption functions. These parameters help to verify the user's identity.

#### **2.4.6 The Equipment Identity Register (EIR)**

The **equipment identity register** is often integrated to the HLR. The EIR keeps a list of mobile phones (identified by their IMEI) which are to be banned from the network or monitored. This is designed to allow tracking of stolen mobile phones. In theory all data about all stolen mobile phones should be distributed to all EIRs in the world through a Central EIR. It is clear, however, that there are some countries where this is not in operation. The EIR data does not have to change in real time, which means that this function can be less distributed than the function of the HLR.

## Chapter 3

### Types of cellular network technologies

#### 3.1 Introduction

Mobile communications are playing an increasingly important role in our business, professional and our personal lives. The demand for mobile communication Services is growing at an unprecedented rate with an expectation that voice, data, Video and internet communications through mobile device could be available anywhere on the globe at all times in the near future.

The increasing use of hand portable mobile telephones, which are operated frequently within buildings, requires the current and the future operators to dimension their networks to provide reliable service in these locations. Initially buildings will be served mainly from external base stations, and so there is a need to understand the penetration losses into a wide range of building types for any orientation of the building relative to the incident field. As demand increases it will be necessary to deploy small cells within buildings, and the key issues here will be the coverage within a room, into adjacent rooms and between floors. Leakage from the building which may cause interference to co-frequency external cells, or co-frequency cells in nearby buildings is also of concern. In buildings with particularly high traffic density it may become necessary to deploy many base stations, some of which may be required to operate co-frequency with one another, and so isolation within a building is also an important issue. Key to the successful control of these demanding requirements is a reliable model for predicting coverage into-and within a wide range of building types.

The signal is received by the outside antenna from cell site. It is then amplified and repeated to user cell phone through the inside antenna. When the phone transmits, the signal is received by the inside antenna, amplified then repeated to the cell site via the outside antenna. Indoor-Building Solution (IBS) is one of technology that use in Telecommunication engineering beside Tower Telecommunication and Roof Top antenna. IBS will provide a mobile signal to all users especially in building. It will Improve signal strength inside a building when using a cell phone and allowing user to walk around freely during a call. It even allows multi phones to be used simultaneously.

A few [2] different building types and possible mobile applications are mentioned:



- **Offices/industries:** —Wireless office, Mobile Extension, corporate Intranet, work orders, supervision, production control, etc.
- **Airports and bus/train stations:** travel information, check-in, booking, local transport information, and duty free/shop advertisement, access to Internet via mobile broadband etc.
- **Conference and exhibition centers:** Portal info, info/notifications, voting, enquiries, visitor feedback, access to Internet/Intranet via mobile broadband etc.
- **Hospitals:** staff/patient communication, patient journal management, reminders/notifications to staff, patient supervision, etc.
- **Hotels:** staff and service management, booking, Internet, check-in, etc.
- **Shopping malls:** advertisement, info to visitors, item search, finding friends, staff communication etc.

The IBS may attract new subscribers due to the enhanced mobile network quality and accessibility to mobile Internet applications and other offered services. In-building solutions may be considered a necessity in a highly competitive market where outdoor coverage is no longer the major differentiating factor. In building solutions offer much more than just coverage. Some drivers for in building solutions are noted in below subchapters.

In building solution we can solved in two ways.

- Active ibs
- Passive ibs

### Active IBS design

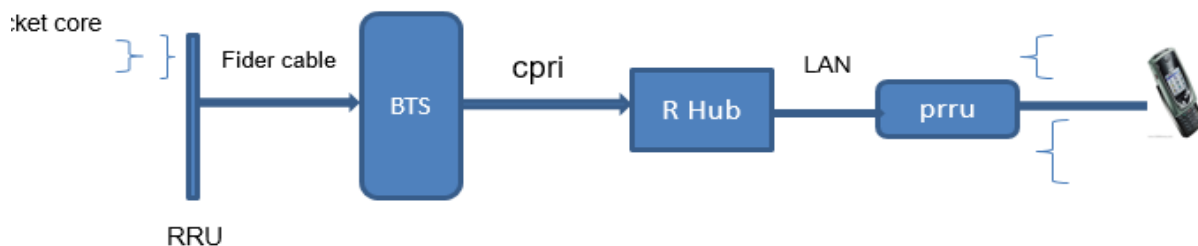

## Passive IBS design

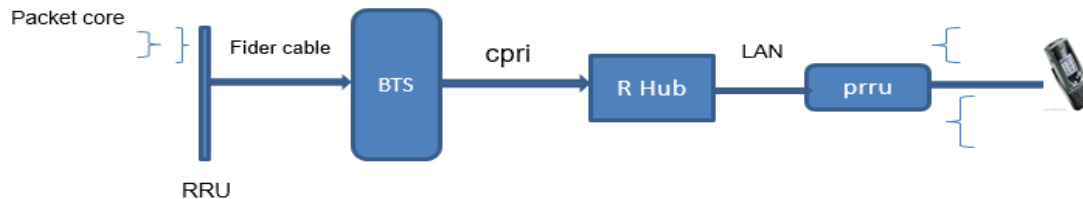

### 3.2 Problem Statements

According to that situation, researcher propose to do a research and study an IBS technology that can give an advantage to all mobile cellular user to make sure they can receive a mobile signal clearly. When one building is build up, sometime there have a problem to receive a mobile signal in one part of building, for example, transmission mobile signal will terminate when researcher enter the basement floor. In this case, the signal in that area is too low to allow the user to make any call. So there is why IBS is needed in the building.

IBS maximize the digital wireless service inside the facilities by extending coverage into previously inaccessible areas, voice and data communications are improved, resulting in direct increases to all user.

IBS be able to predict the coverage in any room on any floor of a wide range of building types. It also provides signal level plots over the area of a room so that large areas of low signal strength (high penetration loss) can be identified include the effect of furniture within each room.

The benefits from this technology are to dedicated radios allocated for user in the building. This will provide more signal in shadowed area. In most cases, the signal in lift lobbies and car parks area are poor compared to the offices. When signal propagates into the building, it will lose its power as it penetrates through glass windows, concrete wall and etc. By the time the signal research the center of the building or the underground car park, it becomes very weak. Therefore, installing antennas inside the buildings can solve the problem.

### **3.3 Project Objectives**

The purpose of this project is to find out signal coverage in a room by determining number and location of the Omni-directional antenna, large rooms. The purpose of the development of a cellular network system Indoor almost the same as regular cell planning or outdoor is to get good coverage. We will identify the weak signal strength of Obontika Colortex an election commission building an election commission building indoor building and we will recovery weak signal strength use by Omni-directional antenna with RBS and other necessary equipment's for IBS system.

- Improve network coverage
- Increase network traffic capacity

## Chapter 4

### Types of cellular network technologies

#### 4.1 What is an In-Building Solution & Why is it required?

It is [2] a process, where in we radiate adequate Mobile signals of one particular Network operator in that entire building. In places like basement floors, higher floors of some high rise Buildings, Airports, Corporate offices, Hotels & Shopping malls we tend to get signals from different cell sites around the building, so subscriber mobile ping-pong from one cell site to another resulting in high CALL-DROPS & High BER (Rx Quality) In some case when the subscriber base increases, the Network operator has difficulty in planning new BTS. So instead of deploying a Macro Site the operator uses a Micro BTS where in the signal from Micro BTS will be distributed throughout the building using Co-axial cables and distributed antenna system. By doing so, we will have uniform signal been radiated all throughout the building providing an error free Network connection to all their valuable subscribers present in that building. In the basement floors there will be absolutely no mobile signals present, so this problem also can be solved using a distributed antenna system in that floor.

#### 4.2 Network Problems inside Buildings

- High Call [2] drops above 4th or 5th floors (Due to Multi cell Hand over)
- High Bit Error Rate - Due to Multi-path propagation, Water refraction, Interference from other cell sites of same operator or other operators
- No network Coverage - Basements, Ground Floors etc. (Penetration loss)
- Subscriber base increases – If deployments of new BTS sites are not possible

### 4.3 General RF Requirements of a customer

- Quality of [2] Service
- Customer requirements > Rx level must be - 80dBm @ 95% Location
  - Probability
- Server from in building solution in dedicated mode > = 90%
- Call Setup success rate = 98% in the entire building
- Drop Call Rates < = 2%
- DL Rx Quality (0 – 2) > = 90 % in the entire building
- DL Rx Quality (0 – 4) > = 95 % in the entire building
- Spillage of signals must be < = -85dBm, on the street and the adjacent buildings
- Frequency planned for Indoor coverage must be carefully planned
  - Parameter settings for IBS must be carefully planned (ex: - hopping frequency, MAIO, HCS etc.

## **Chapter 5**

### **Indoor building solution site survey**

#### **5.1 Introduction**

The first [3] activity that should take place when considering the implementation of an indoor coverage system is the site survey. Results of all survey work, whether in paper and electronic form, should be copied at the end of each working day. The original and the copy of the data should be stored in physically separate locations. All survey records (source data) should be forwarded to the design engineer responsible for the project, not just a summary, or the subsequently calculated result. These records should then be added to the project design documentation archive. The importance of thoroughly understanding the requirements, planning, and executing this task in a comprehensive manner cannot be overstated.

#### **5.2 Important**

GSM systems may operate in either the 900MHz band or the 1.8/1.9GHz bands. At the higher frequency bands, the radio signals suffer greater loss. It is therefore essential that the intended operating frequency band is determined prior to the start of the survey and design processes.

#### **5.3 What Type of site survey elements**

- There are four basic elements to the site survey:
- Physical survey
- Internal building propagation loss
- External building propagation loss
- Signal level received from outdoor cells

#### **5.4 Physical building survey**

This activity [3] aims to collect data which can be used to determine in broad terms the type of indoor coverage system that is most suitable for use in the structure concerned. It is therefore necessary to gather as much detail as possible during the first visit, together with contacts associated with the building, which can be used to confirm information, or obtain further details, without the need of subsequent visits.

### 5.4.1 Required data:

The data listed below should be gathered:

- **Contact details for people /organizations involved with the building:**

- ❖ Owner(s), tenant(s), planning (zoning) authority, utilities, and emergency services (security and medical)

- **Location of the building:**

- ❖ National Grid Reference (NGR), Universal Transverse Mercator UTM, or geographic co-ordinates.

- **External dimensioned sketch:**

- ❖ Plan and elevation
- ❖ Indicate construction materials used
- ❖ Show site boundary and major features
- ❖ Mark access and restrictions, loading and parking facilities

- **External site photos:**

- ❖ Print in territory and repeat as necessary
- ❖ Particular attention to areas where work will be conducted (such as cable routes)
- ❖ Ensure state of building is documented before work starts (for later reinstatement)

- **Internal dimensioned floor sketch**

- ❖ Plan and elevation
- ❖ Particular attention to equipment room
- ❖ Show ducts, risers, and capacity, hanging arrangements, fire stops and material etc.
- ❖ Indicate construction materials used

- **Internal site photos:**

- ❖ Print in territory and repeat as necessary
- ❖ Particular attention to areas where work will be conducted (such as cable routes, equipment room, antenna sites)
- ❖ Ensure state of building is documented before work starts (for later reinstatement)

- **Specific installation problems:**

- ❖ Building protection, specific working practices, staff training/certification/approval and any preferred materials to be used
- ❖ Security of staff and equipment (official enquiries and informal comments from local staff)
- ❖ Measures to minimize disruption (such as out-of-hours work), access restrictions

- **Fire precautions:**

- ❖ Cable certification
- ❖ Material for fire stops and need for recertification
- ❖ Use of hazardous installation equipment

- **Environmental hazards:**

- ❖ Protection of staff (such as clothing, ear defenders, hard hats, footwear)
- ❖ Need for intrinsic safety, restrictions of type of batteries used in equipment
- ❖ Corrosive atmosphere, radiation, and high voltage barrier zones
- ❖ Building construction material (such as asbestos, glass fibre)
- ❖ Wind-speed, ice, and Ultra Violet (UV) radiation for external installations

- **EMC requirement**

- ❖ Existing radiating cable and/or antenna systems:
- ❖ Location, coverage, owner contacts, operating system and so on Existing protective bonding, earthing, lightning protection system:
- ❖ Location, coverage, owner contacts, condition, type, connector details, test certificate and so, on

- **Predicted traffic load:**

- ❖ Expected growth
- ❖ Location in building and any changes anticipated



**•Power:**

- ❖ Availability, reliability, source and voltage (such as mains, UPS, generator)

**•Landline telecommunications:**

- ❖ Availability, reliability, source contacts, type (such as analogue or digital services)
- ❖ Availability of viable radio path to existing base stations, and PTO fixed circuit
- ❖ Distribution Nodes (DNs) or Points of Presence (PoPs)

The above basic information, in the majority of cases where a straightforward deployment is involved, coupled with data from the existing mobile phone PTO, will allow engineers to produce the first level of system design, using a combination of manual techniques, past experience, and computer coverage prediction software.

### **5.5 Internal building propagation loss**

This activity [3] aims to collect data regarding the extent to which the radio signals suffer loss (for example: shadowing, absorption, field strength reduction with distance) when passing (propagating) through the internal structure of the building. In a building with many rooms and floors, it is likely that the direct path between the base station antenna (whether discrete element or provided by radiating cable) and mobile antenna, will be interrupted by internal walls, partitions, and furniture. The extent to which these internal features of the building reduce (attenuate) the signal level varies according to the construction material and fittings used. Although a rough approximation of the internal building loss can be found from the data gathered during the physical site survey, wherever possible, it is recommended that actual measurements are made. Measurements give a degree of confidence that cannot be gained by other means. Tests are normally conducted on sample areas of the building, which are chosen to be representative of the whole structure. The test results can be used to improve the accuracy of computer predictions, such that it can be used in the rest of the building

### 5.5.1 Test procedure

The basic method used to measure internal building attenuation is to install a test source and conduct practical field strength measurements. This process is outlined below:

- ❖ The building is examined and areas categorized according to the different internal Characteristics found:
  - Different materials and construction techniques used
  - Extent of internal subdivision (rooms and large open areas)
  - Extent and nature of internal fixtures and fittings
- A small number of areas of the building are selected for testing, which represent the range of categories of internal characteristics found, and the following tests are conducted in each representative area
- A test source, operating at the intended operating radio frequency of the indoor coverage system, is installed in the test area:
  - Although the test signal can be radiated at low power, it is usually necessary to gain approval from the regulatory authority in the territory concerned
  - The test signal can either be radiated from an antenna, or from a test length of radiating cable, according to the type of indoor system envisaged
  - The test antenna should be installed as close as possible to the intended location for the final deployment
  - The characteristics of the test source, cables, and antenna should be recorded (such as transmit power, loss, and location)
- A test receiver, capable of receiving and unambiguously identifying the test signal, is moved through the test area indoor coverage area required:
  - ❖ Measurements may need to be concentrated in the most populated parts of the building, in areas where coverage is essential for safety reasons (although infrequently used), and
  - ❖ areas where coverage is expected to be most difficult to achieve (from the intended antenna/radiating cable sites)

- The level of the test signal received by the test receiver is recorded:
  - When measurements are conducted at a series of test points, (rather than continuously along a test route), at each test point three measurements should be taken, at the points of an imaginary triangle of side 1m, centered on the test point. The average of the three measurements should be used as the received signal level assigned to the test point
  - If only a single measurement is made at each fixed point, accuracy will be significantly impaired by marked variations in the received signal level in the vicinity of the test point
- These tests may be performed:
  - ❖ Following the initial system design stage
  - ❖ During the detailed design stage (to finalize antenna locations)
  - ❖ Following installation (to optimize antenna locations)

## 5.5.2 Required equipment

It is recommended that the following equipment is available for measuring internal propagation loss.

- Test source
  - ❖ Ericsson \_TEMS Test Transmitter and Accessories Case (for use where GSM radio channel is available for test purposes)
  - ❖ Ruggedized signal generator, digital synthesized, AC/DC powered (for used where GSM radio channel is not available for test purposes)
  - ❖ Mileage linear power amplifier (for use with above where higher output power is required)
- Test receiver
  - ❖ Safeco \_Walkabout System - Sagem Dual Band' (for use where GSM radio manual entry to provide the location of the test measurement
  - ❖ Portable ruggedized spectrum analyzer (for use where GSM radio channel is not available for test purposes). Depending on the minimum detectable signal this can receive, and the test source transmitted power, a low noise pre-amplifier may also be needed.

## **5.6 External building propagation loss**

This activity [2] aims to collect data regarding the extent to which the radio signals suffer loss (such as screening, absorption, and field strength reduction with distance) when passing through the external walls of the building.

This information is used to determine the extent to which the indoor coverage system may cause interference with any existing outdoor cells. It may be possible to effectively contain the radio signals from the indoor coverage system within the building, by means of using relatively low power, and effective screening by the external building walls. Under these circumstances it may be possible to use the same radio channels indoors and outdoors, without causing unacceptable interference to mobiles using the outdoor cell. The containment of the indoor signals within the building minimizes the chance of outdoor mobiles using the indoor system, which may not be desirable.

As in the case of the internal building loss, an approximation to the external building propagation loss can be found from the data gathered during the physical site survey; however, wherever possible, it is recommended that actual measurements are made. Again, tests are normally conducted on sample areas of the building that are chosen to be representative of the whole structure. The results from these tests can be used to improve the accuracy of computer predictions, such that it is sufficient for use in the rest of the building.

### **5.6.1 Test procedure**

The method used to measure external building propagation loss is similar to that for internal building propagation loss outlined in the previous section. However, the representative test areas are based on the external wall characteristics of the building, and the test receiver is located outdoors, as follows. The building is examined and areas categorized according to the different ground floor external wall characteristics found (such as different materials and construction techniques used)

- A small number of areas of the building are selected for testing, which represent the range of categories of external wall characteristics found, and the following tests are conducted in each representative area

- A test source, operating at the intended operating radio frequency of the indoor coverage system, is installed in the test area:

Although the test signal can be radiated at low power, it is usually necessary to gain

- ❖ approval from the regulatory authority in the territory concerned

The test signal can either be radiated from an antenna, or from a test length of radiating

- ❖ cable, according to the type of indoor system envisaged

The test antenna should be installed as close as possible to the intended location for the final

- ❖ deployment

The characteristics of the test source, cables, and antenna should be recorded (such as

- ❖ transmit power, loss and location)

- A test receiver, capable of receiving and unambiguously identifying the test signal, is moved through the outdoor test area adjacent to the building, in the vicinity of test source installed indoors:

- Test routes (or test points) are identified at different ranges from the external wall of the building
- Measurements may need to be concentrated in the areas where greatest leakage from the indoor building system, to the outdoor environment is anticipated

- The level of the test signal received by the test receiver is recorded

- When measurements are conducted at a series of test points, (rather than continuously along

a test route), at each test point three measurements should be taken, at the points of an imaginary triangle of side 1m, centred on the test point.

- The average of the three measurements should be used as the received signal level assigned to the test point If only a single measurement is made at each fixed point, accuracy will be significantly impaired by marked variations in the received signal level in the vicinity of the test point

- These tests may be performed:

- ❖ Following the initial system design stage
- ❖ During the detailed design stage (to finalize antenna locations)
- ❖ Following installation (to optimized antenna locations)

## **5.6.2 Required equipment**

It is recommended that the same equipment is available for measuring the external building propagation loss, as is listed on page 18 for measuring the internal propagation loss. If a TEMS Test Transmitter is not available, a suitable portable signal generator can be used almost as easily in existing buildings, with readily available electricity supply. The following figure illustrates the use of such a set-up, where the signal generator feeds a test length (~10m) of radiating cable, installed above a suspended ceiling.

## **5.7 In building solution proposal**

### **Radio Network [2] Plan – RNP Report**

- Solution description i)Passive Distribution ii)CAT-5 Distribution
- Coverage plan
- System diagram
- Power budget calculation
- Proposed antenna location photograph
- System layout on floor plan ( ACAD)
- Measurement results

### **RNP Report Solution Descriptions**

#### **Overview**

Network Solution passive coaxial & Antenna distribution or LGC network

#### **Coverage Plan (i.e.) intended Coverage area**

Based on the questionnaire or customers requirement, How many levels? Basement, Car park, Lift lobby, toilets, staff area etc., where all the coverage required

## **Bill of Materials**

Details of How many antennas (Omni, Panel), Cable type (1/2" or 7/8"), Splitters, Couplers

## **Macro/ Micro BTS Accommodation**

- ❖ Type of BTS (Micro, Macro, flexi talk etc., based on output power )
- ❖ BTS Location (to be placed in which floor? Is there any other BTS installed by other network operators?)
- ❖ BTS configuration ( 1+1+1 or 2+2+2)

## Chapter 6

### Installation of BTS 3900/3900L/3900A

(includes the following activities)

#### 6.1 HUAWEI BTS 6900/6900L/6900A

GRAMEEN PHONE Bangladesh Ltd. had signed up a contract with Huawei Corporation as their equipment supplier. HUAWEI Corporation delivered us with their BTS model BTS 6900/6900L/6900A and our BTS equipment installation works begins. In the tenure at GRAMEEN PHONE Bangladesh Ltd. i had to work for installing BTS 6900/6900L/6900A. It is the radio equipment (transceivers and antennas) needed to service each cell in the network. A group of BTSs are controlled by a BSC. In a large urban area, there will potentially be a large number of BTSs deployed, thus the requirements for a BTS are ruggedness, reliability, portability, and minimum cost. [1]

#### 6.2 Position in the System

The BTS 6900/6900L/6900A interconnects the MS via the Um interface with the trunk network via the Abis interface.

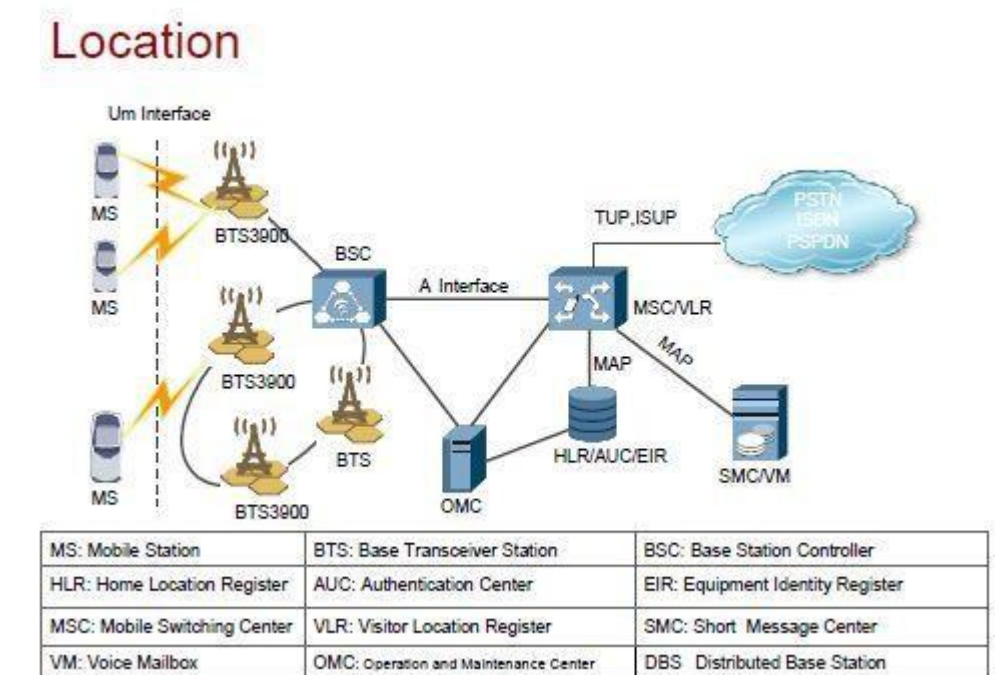

Fig. 6.1: Position of the Base Station within the SBS [1]



### 6.3 Site Requirements

For GP Swap it is important, that the installation site must have all the required installation equipment. Prior to the commencement of installation, the site have to be prepared as follows:

- The BTS 6900/6900L/6900A with required MRFU/RRU.
- Environment Monitoring Unit with 9 pin alarm cable and Temperature sensor.
- Balun, E1 cable and Twisted Pair cable for E1 connection
- 6 amp circuit breaker for EMU and 66 amp circuit breaker for BTS. For double cabinet need two 66 amp circuit breaker.
- All installation works of 6 phases 260 V AC or -48 V DC power supply, including a circuit breaker in each phase or the -48 V DC line have to be finished.
- 12 pair cable, all power cable, and all grounding cable.

### 6.4 Site Engineer Requirements

In GP swap for commissioning site Engineer need this following tools:

- Laptop with BTSM software
- Tems mobile with Net Monitor software
- BTS login cable, Puncher, Loop cable, Gullu, and LED
- PAT documents.

### 6.5 BTS 6900/6900L/6900A configuration

The BTS6900/BTS6900L/6900A developed by Huawei is an indoor macro BTS. The BTS6900/BTS6900L/6900A mainly consists of the BBU and MRFUs/RRUs. Compared with traditional BTSs, the BTS6900 features simpler structure and higher integration. BTS 6900 is single cabinet and BTS 6900L is double cabinet. BTS6900A is OUTDOOR cabinet.

- ❑ BTS 6900 Cabinet size: H×W×D=900mm×600mm×450mm Weight: 57kg (empty) /142kg (full configuration)
- ❑ BTS 6900L Cabinet size: H×W×D=1600mm×600mm×450mm
- ❑ BTS 6900A Cabinet size: H×W×D=1600mm×600mm×480mm

**6.6 BTS Components**

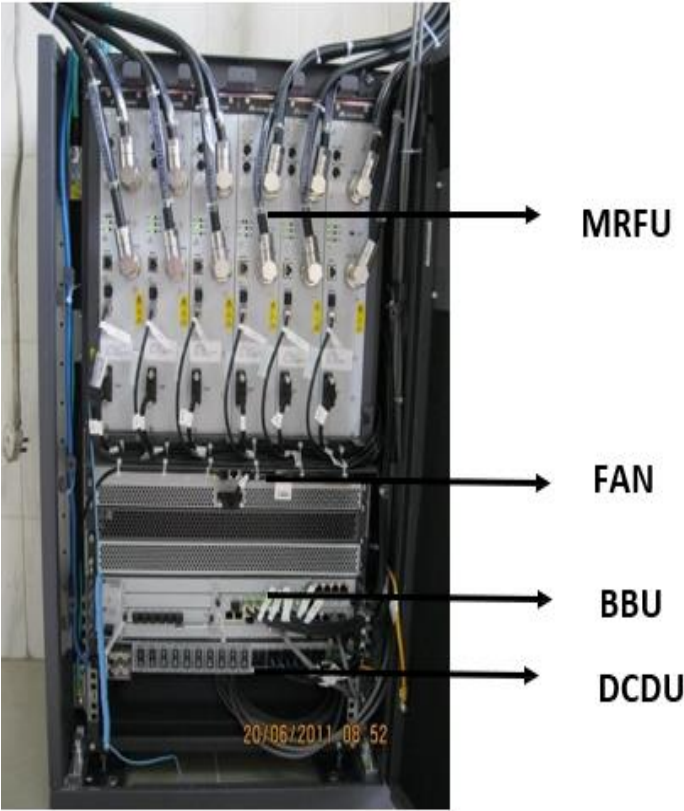

Fig. 6.2: BTS 6900 component



Fig. 6.3 BTS 6900L component

### 6.6.1 MRFU – Multicarrier Radio Frequency Unit

Year of 2009 swap E/// RBS was done by BTS6900 with DRFU carrier. But now HUAWEI new carrier is MRFU so 2011 swap all BTS6900 and BTS6900L will configure the MRFU carrier and HUAWEI zone DRFU BTS6900 sites also will replace the DRFU by MRFU.

- ❖ Multicarrier radio frequency unit (MRFU) support GSM and 6G. There are two types of MRFU, that is MRFU of 900 MHz and MRFU of 1800 MHz.
- ❖ The MRFU performs modulation, demodulation, data processing, and combining and dividing for baseband signals and RF signals. MRFU support 6 TRX but in GP use only 4. It has 1 TX and 2 RX port. [1]

### 6.6.2 BBU – Base Band Unit

- ❖ The BBU is a small box with all the external ports on the front panel.
- ❖ The typical power consumption of the BBU is 50 W.
- ❖ The BBU6900 boards consist of the BSBC, UEIU, GTMU, UBRI, UELP and UPEU.
- ❖ Provides ports for communication between the base station and the BSC/RNC and Processes uplink and downlink data
- ❖ Provides CPRI ports for the communication with the RF modules [1]



Fig 6.4: Base Band Unit

### 6.6.3 FAN

- ❖ A fan unit contains a fan sub rack, four fans, and an FMU
- ❖ Provides forced ventilation and dissipation for the cabinet.
- ❖ Detects the temperature.
- ❖ Communicates with the central processing unit to report alarms and the adjusted rotation speed of the fans based on

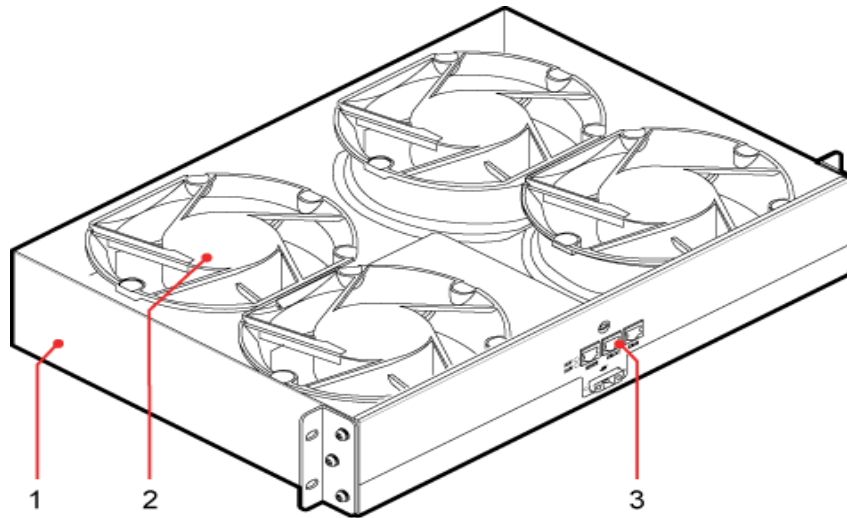

Fig 6.5: FAN

PAA01C0001

- (1) Fan subrack
- (2) Fan
- (3) The FMU

### 6.6.4 DCDCU - DC Distribution Unit

The direction current distribution unit (DCDCU-01) provides -48V DC power of 10 outputs.

The functions of the DCDCU-01 are:

- ❖ Receiving -48 V DC power input.
- ❖ Distributing the -48 V DC powers of 10 outputs for boards and modules in the cabinet.

## DCDCU-01 Module

- ◆ Panel of the DCDCU-01 (10 outputs)

Name	Label	Description
Power input terminal	NEG(-)	DCDCU-01 low level input terminal
	RTN(+)	DCDCU-01 high level input terminal
Power output port	SPARE2, SPARE1, BBU, FAN, and RFU5-RFU0	Power ports supplying the 10 outputs of power to the BBU, DRFU, GATM, and fan box
Power switch	SPARE2, SPARE1, BBU, FAN, and RFU5-RFU0	Power switch controlling the 10 outputs for the BBU, DRFU, GATM, and fan box
Alarm output port	SPD ALM	Dry contact alarm output port

Table – 6.1 Panel of the DCDCU

## 6.7 Typical configuration of MRFU

Single MRFU.

- ❖ Double feeder, 1TX + 2RX.
- ❖ When a dual-polarized antenna is configured, one TX channel and two RX channels are supported. The ANT\_RXB and ANT\_TX/RXA ports receive the signals from the antenna to achieve RX diversity.

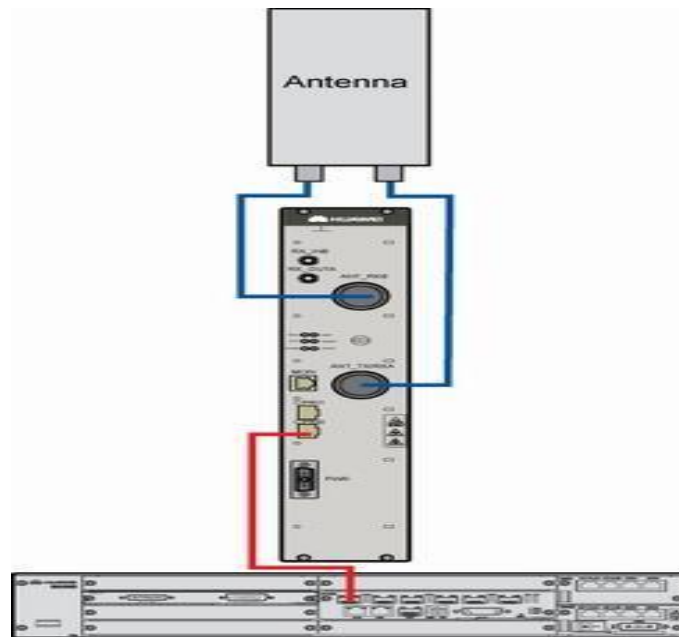

Fig-6.6: Single MRFU

Two module interconnections

- ❖ Single feeder, 1TX + 2RX.
- ❖ When the cell configuration is from S7 to S12, two MRFUs need to be configured.
- ❖ The ANT\_TX/RXA port on each MRFU supports the receiving and transmitting of signals. Two MRFUs provide RX signals for each other through the RF interconnection ports. Thus, the RX diversity is implemented.

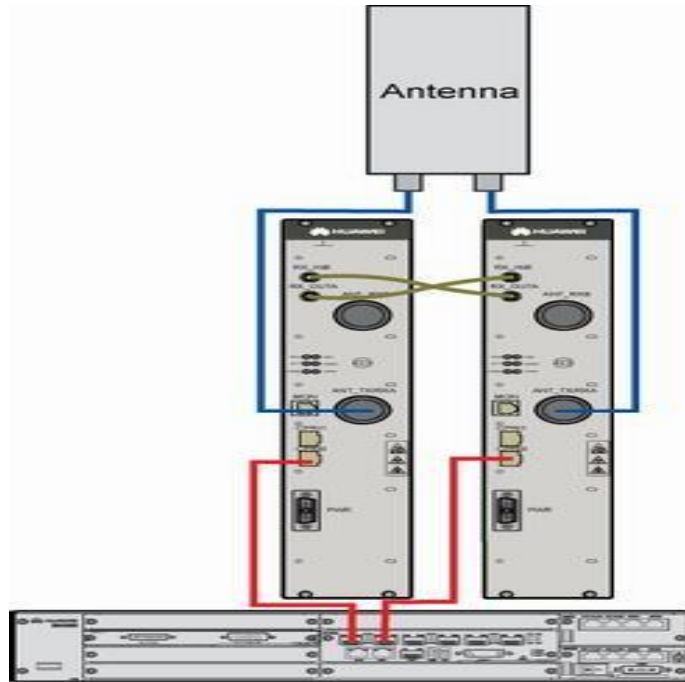

Fig-6.7 Double MRFU

Normally an MRFU support six TRX but Grameen Phone use only four TRX. Suppose a configuration is given for gsm 900 is S4/4/4 and for gsm 1800 is 4/12/8. For gsm 900 we will use three MRFU card and for 1800 we will use six. In this configuration MRFU card of slot number 7,8 and 10,11 will be cascaded.

S444+S4/12/8  
M1~3: 900M Cell  
G7~9:1800M Cell

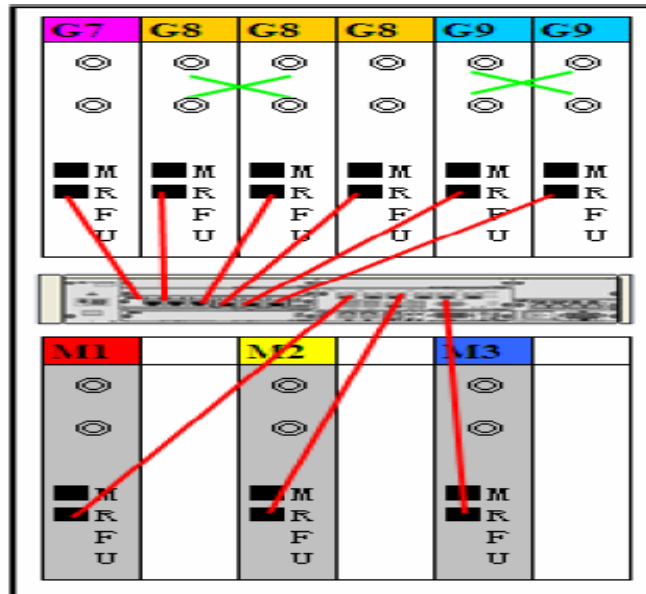

Fig-6.8 S4/4/4 and S4/12/8

Here all the 900MHz are connected to GTMU and 1800MHz are connected to UBRI. For single cabinet all the 900 & 1800 are connect from GTMU.



## 6.8 GP SWAP WORK FLOW

GP swap activities are done by two steps. First one is renovation or pre-swap and second is swap night activities. There are four team members under a Engineer for GP swap. Swap Engineer need site key, survey report, material list or DN, GP notification letter, PAT documents and all the commissioning tools. To get the entry permission to site; site Engineer have to text a sms to GP hotline number – 9876. And site Engineer number must be authorized to get acknowledge by SOC. The exit procedure is same as entry procedure.

The Entry and Exit procedure are given below:

### Entry procedure:

Activity	Format	Send to	Returned SMS
Swap	IN#Site name#PLW (IN#DHSLB1#PLW)	9876	Entrance into DHSLB1 planned work acknowledged by SOC at 3:40:40 PM
Dismantle	IN#Site name#INT (IN#DHSLB1#INT)		Entrance into DHSLB1 integration acknowledged by SOC at 3:40:40 PM
Survey	IN#Site name#SVI (IN#DHSLB1#SVI)		Entrance into DHSLB1 site visit acknowledged by SOC at 3:40:40 PM
Operation	IN#Site name#PMT (IN#DHSLB1#PMT)		Entrance into DHSLB1 preventive maintenance acknowledged by SOC at 3:40:40 PM
Site preparation	IN#Site name#PRW (IN#DHSLB1#PRW)		Entrance into DHSLB1 planned related work acknowledged by SOC at 3:40:40 PM

### Exit procedure:

Activity	Format	Send to	Returned SMS
Swap	Out#Site name#PLW (Out#DHSLB1#PLW)	9876	Exit from DHSLB1 planned work acknowledged by SOC at 3:50:40 PM
Dismantle	Out#Site name#INT (Out#DHSLB1#INT)		Exit from DHSLB1 integration acknowledged by SOC at 3:50:40 PM
Survey	Out#Site name#SVI (Out#DHSLB1#SVI)		Exit from DHSLB1 site visit acknowledged by SOC at 3:50:40 PM
Operation	Out#Site name#PMT (Out#DHSLB1#PMT)		Exit from DHSLB1 preventive maintenance acknowledged by SOC at 3:50:40 PM
Site preparation	Out#Site name#PRW (Out#DHSLB1#PRW)		Exit from DHSLB1 planned related work acknowledged by SOC at 3:50:40 PM

Table-6.2: SMS sending procedure of Entry & Exit

## 6.9 Pre-swap activities:

At first i have to check all of the material according to delivery note. If there is any shortage then i have to mail for shortage requisition. Then the EMU box is installed as per room drawing and HUAWEI DDF is installed in TX rack. Then latching of power cable, grounding cable, alarm cable, E1 cable is done very carefully. All connector are made according to GP standard.

### 6.9.1 EMU- Environment Monitoring Unit

Gp use EMU box for checking ten external alarms. All alarm sensors are connected to Huawei DDF and from DDF an twelve pair cable are connected to EMU. From BTS a nine pin alarm cable are connected to EMU box. Outline dimension of an EMU is 252 mm [9.92 in.] x 209 mm [8.26 in.] x 91 mm [6.58 in.] (Excluding the dimension of the cord end terminal)

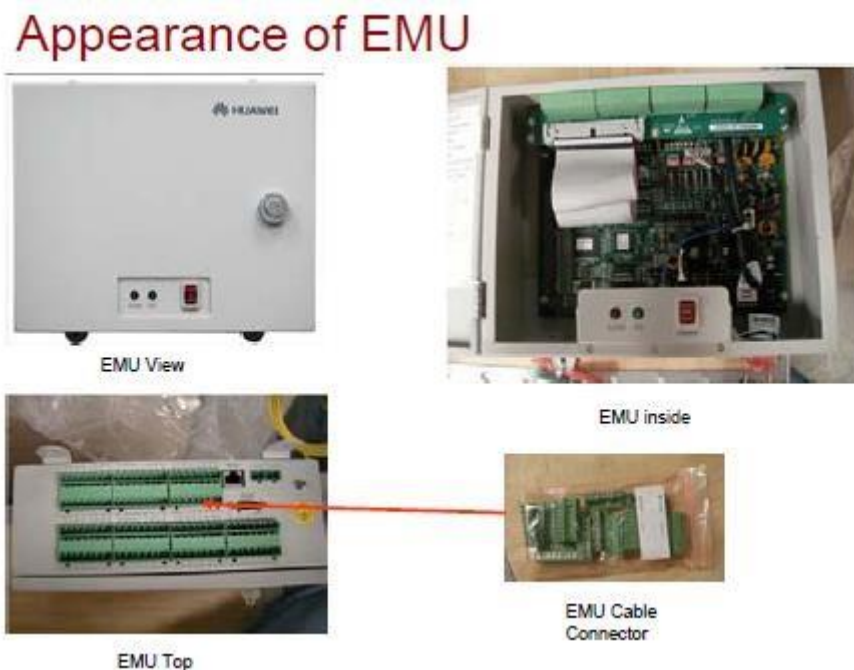

Fig-6.9: Environment Monitoring Unit

Laying the cable of alarm box:

- Power cable
- Monitor and alarm cable
- 12 pair cable
- Grounding cable



## 6.9.2 Placing Huawei DDF

Normally Huawei DDF is placed in existing TX rack. In a DDF have eight port for alarm and eight for E1 connection. Alarm is connected to left side of the DDF and E1 are connected to right side. A temperature sensor is placed in left side of the DDF. Because of having 10 external alarms GP use two DDF for alarm connection. There are some cases for placing

DDF in TX rack.

**Case 1:** If there is an OVP in site then the existing Ericsson OVP box will dismantle during swap and Huawei DDF will place in TX rack.

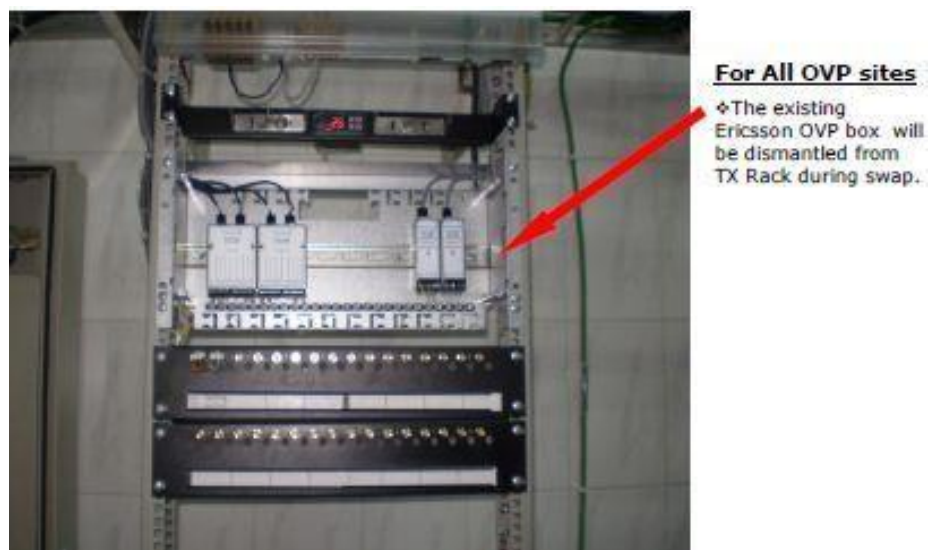

Fig-6.10: TX rack with OVP

**Case 2:** Where OVP is not present at TX rack the Huawei DDF will normally place at upper side of the TX rack.

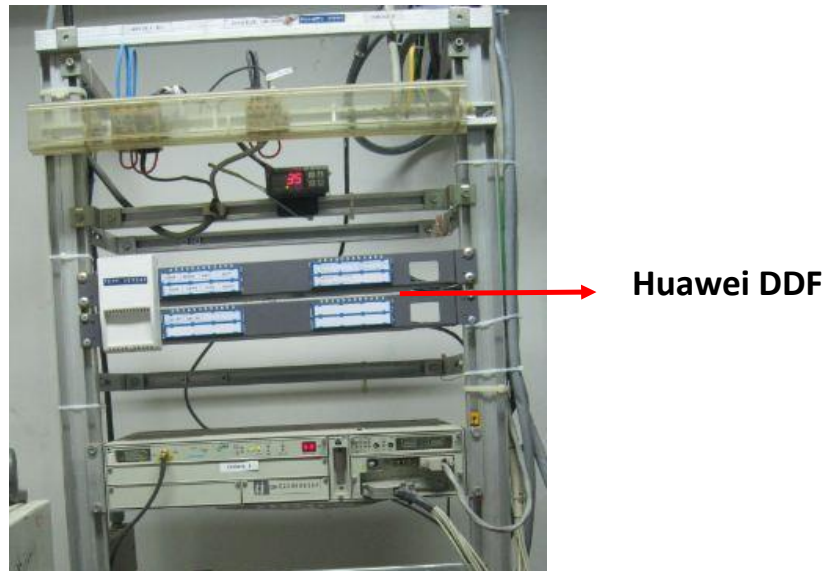

Fig-6.11: TX rack with Huawei DDF

### 6.9.3 Temperature Sensor

Normally Temperature sensor is placed at left side of the Huawei DDF. Because the cable length (around 6m) of the Temp sensor GP require install the sensor on TX rack.

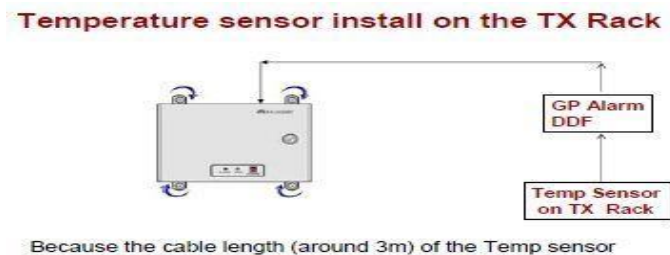

Fig-6.12: Temperature sensor

### 6.9.4 Connector making:

Ericsson RBS are connected to antenna through jumper cable which are flex cable. Huawei BTS get connect with this Flex cable through Super Flex cable. For connecting this cables there are three kinds of connector such as super flex right angle male connector, super flex straight female connector and flex straight mail connector. GP have some standard to making these connectors:

L-Connector: pin – 9mm; grounding – 16.5mm I-connector: pin – 6.5mm; grounding – 12mm.

The process of making connector is given below:

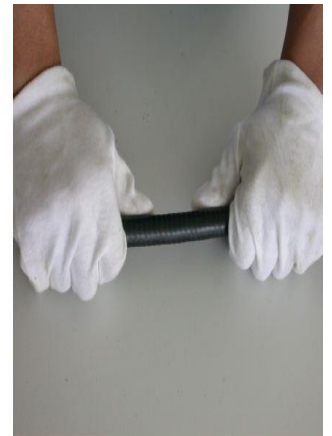
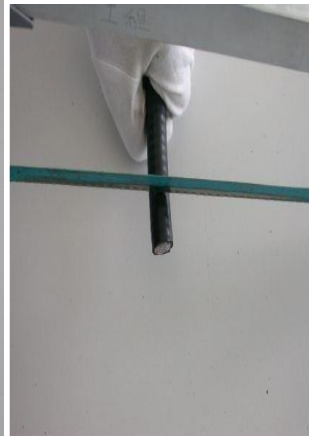

## Installation tools

*Before stripping, saw the first 50mm cable and make the surface flat and the cable straight*

Fig: 6.13 connector making tools

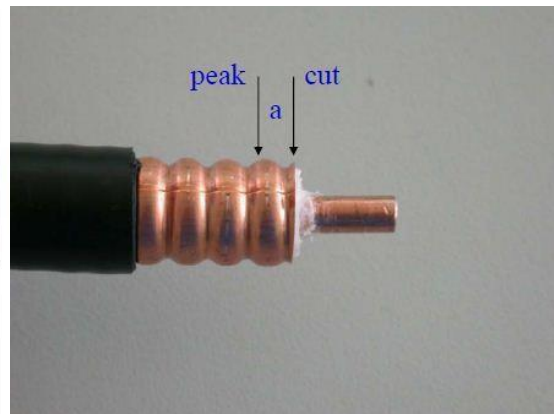
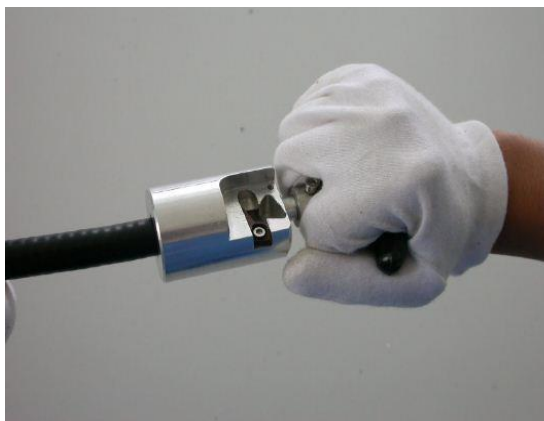

*Insert cable into the stripping tool and rotate the tool* *At the first stripping, the outer conductor maybe not cut on the peak of corrugation*



*Then we should clip the center conductor by the distance between the cut and the next peak (a) and stripping the cable again*

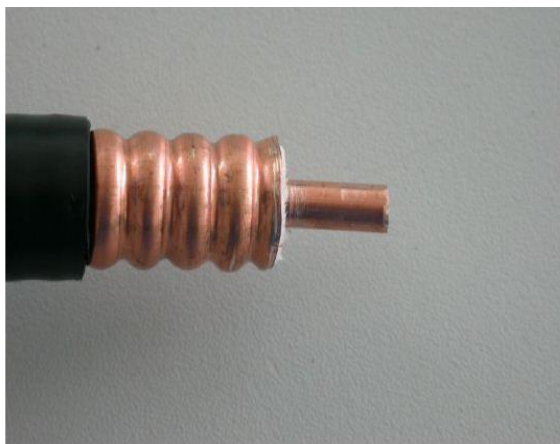

*After the stripping the outer conductor must be on the peak of the corrugation*



*Then we insert part B of the connector onto the stripped cable, take care that the ferrule must be snapped in at first corrugation valley*

Fig: 6.14 connector making tools

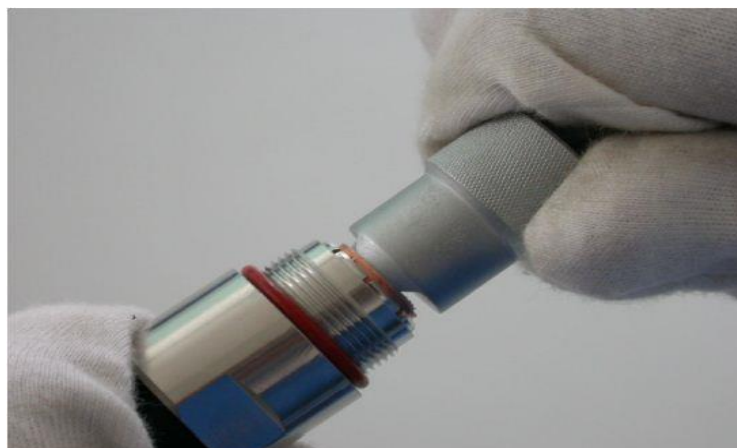

*Enlarge the outer conductor with special tool to make good connection between cable and connector, both electrical and mechanical*

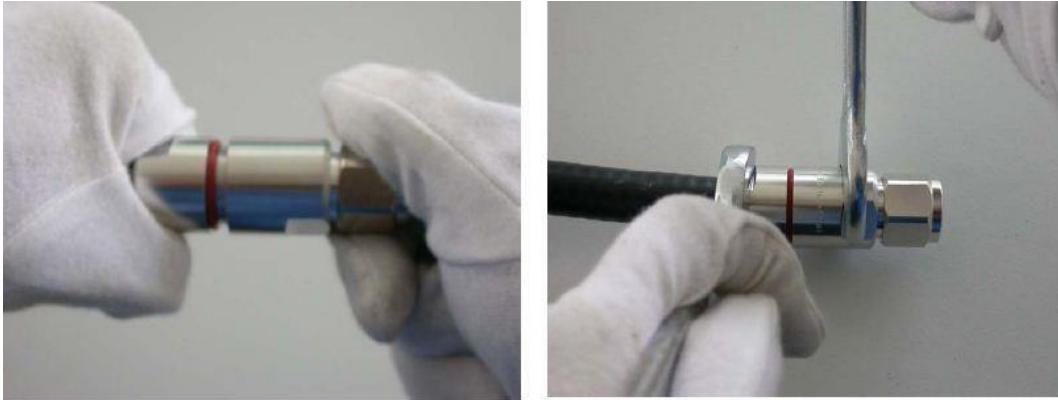

*Screw on the part A and tighten it with two wrenches*

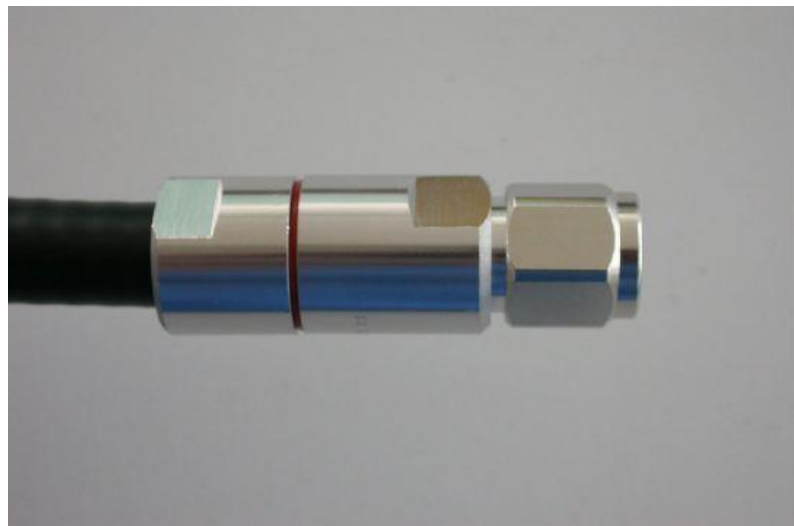

*Finished*

Fig-6.15: Connector making



## 6.10 GP Swap activities

The main activities of GP swap are to dismantle existing Ericsson RBS and install Huawei BTS and proper E1 connection from slim rack to Huawei DDF at TX rack. According to GP standard; total works are done following some procedure. At swap night E1 cable and 12 pair alarm cable are punched into Huawei DDF. When NM ask to dismantle all the existing alarm; then all alarm have to punch in Huawei DDF. Then main works began when site is in local position. When site is in local position existing Ericsson RBS have to dismantle, install the BTS base and BTS, change circuit breaker from rectifier, through E1 from slim rack to DDF, connection of all jumper cable, software commissioning, labeling all cable and alarm according to GP standard, call test , fill up PAT documents. The work flow of GP swap is given below:

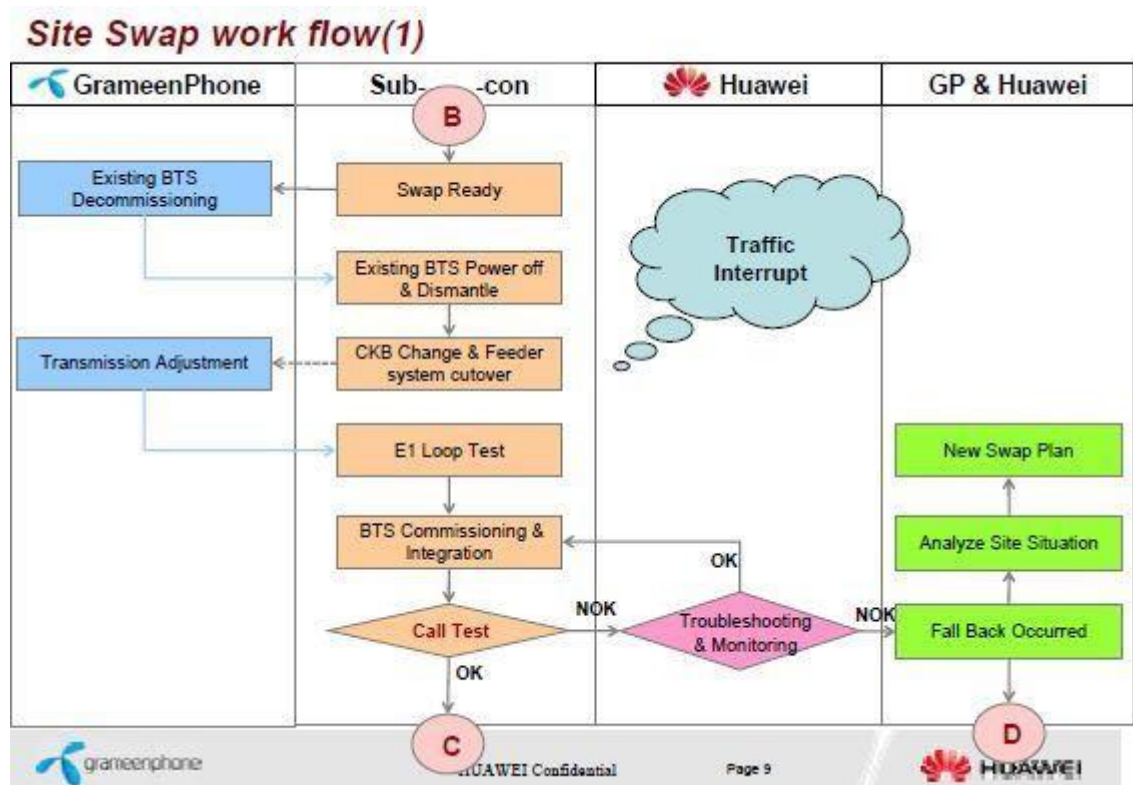

Fig-6.16: GP swap work flow (1)

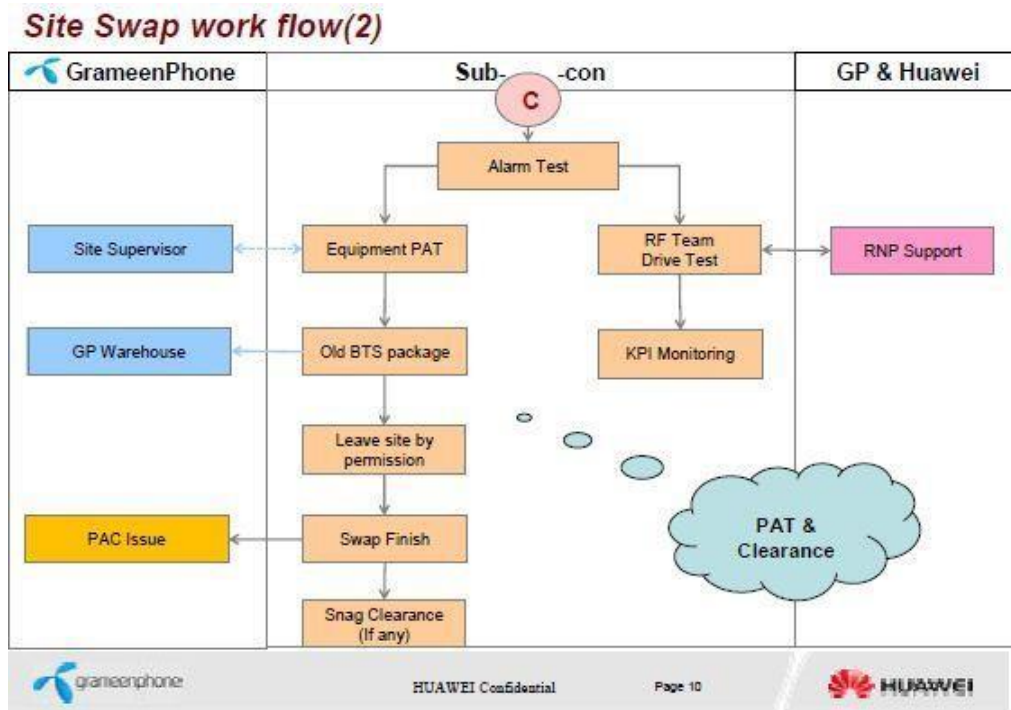

Fig-6.17: GP swap work flow (2)

### 6.10.1 E1 and 12 pair alarm cable connection

E1 cable connects from BTS to Huawei DDF. The pair of E1 cable and alarm cable enter from the left side of the cron box. The cron of E1 connection is in the right side of the DDF and alarm connection is in left side. GP maintain some color code for E1 and alarm connection which are given below:

<b><i>E1 Color Code</i></b>			
<b>1</b>	White	Gray	<b><i>TX1</i></b>
	White	Blue	<b><i>RX1</i></b>
<b>2</b>	Red	Blue	<b><i>TX2</i></b>
	White	Orange	<b><i>RX2</i></b>
<b>3</b>	Red	Orange	<b><i>TX3</i></b>
	White	Green	<b><i>RX3</i></b>
<b>4</b>	Red	Green	<b><i>TX4</i></b>
	White	Brown	<b><i>RX4</i></b>

Table-6.3: E1 color code

<b><u>Alarm Color Code</u></b>				
<b>1</b>	Red	Gray	<b><i>Temp.Alarm</i></b>	alarm0
<b>2</b>	White	Blue	<b><i>Mains Fail</i></b>	alarm1
<b>3</b>	White	Orange	<b><i>Batt.disconnect pre Alarm</i></b>	alarm2
<b>4</b>	White	Green	<b><i>Rect.Module Fail</i></b>	alarm3
<b>5</b>	White	Brown	<b><i>Aviation Alarm</i></b>	alarm4
<b>6</b>	White	Gray	<b><i>Gen.Running</i></b>	alarm5
<b>7</b>	Red	Blue	<b><i>Fuel Level low</i></b>	alarm6
<b>8</b>	Red	Orange	<b><i>Water Level High</i></b>	alarm7
<b>9</b>	Red	Green	<b><i>Door Open</i></b>	alarm8
<b>10</b>	Black	Brown	<b><i>Door Open AG</i></b>	alarm9

Table 6.4: GP alarm color code



### 6.10.2 Installing base plate and BTS

The BTS rack must be firmly fixed on its base and base bolt should be tighten properly 45 N-m.



Fig-6.18: Fixing the Huawei BTS and install BTS over base

### 6.10.3 Changing circuit breaker

There are five kinds of rectifier used by Grameen phone. They are:

- ❖ DELTA
- ❖ ASCOM
- ❖ ELTEK
- ❖ BSMC
- ❖ BSMC-BD

During swap circuit breaker of non-critical position will be replace. For double cabinet need two circuit breakers of 66A and for single cabinet need one circuit breaker of 66A. For EMU need only one 6A circuit breaker.



POSITIVE POWER CONNECTION for BTS & EMU AT RECTIFIER END



CRIMP THE LUG USED FOR POWER CABLE



NEGATIVE POWER CABLE CONNECTION AT RECTIFIER END



LATCHING THE POWER CABLE AT RECTIFIER END



POWER CABLE CONNECTION AT RECTIFIER END



POWER CABLE CONNECTION AT RECTIFIER END



POWER CABLE CONNECTION AT RECTIFIER END



USE PROPER LUG FOR POWER CABLE

Fig 6.19: Changing breaker in Rectifier



### 6.10.4 Jumper cable connection to BTS

After making all of the Flex male connector has to connect super flex cable to Flex cable. All of the connector must be proper tightening with torque 25N-m and we should care of no cell miss match.



CONNECT THE SUPER FLEX JUMPER AT  
BTS END



MAKE SUPER FLEX I CONNECTOR



TIGHTEN THE CONNECTOR PROPERLY



TIGHTEN THE CONNECTOR WITH TORQUE

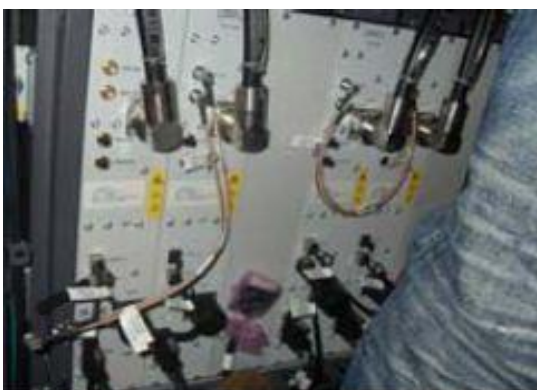

CONNECT THE SUPER FLEX JUMPER AT  
BTS END



MAKE SUPER FLEX I CONNECTOR

Fig-6.20: Jumper cable connection

### 6.10.5 BTS power

After latching all of the power cable first have to ON the circuit breaker and measure the voltage in multimeter. The BTS voltage must be -48 V.



LATCHING THE POWER CABLE AT BTS END



LATCHING THE POWER CABLE AT BTS END



CUT THE ISOLATION OF POWER CABLE



USE PROPER CABLE SHOE



PROPERLY PUNCH THE SHOE BY HYDROLIC PUNCHER



USE HEATSHRINK FOR CABLE SHOE

Fig-6.21: Power ON and measuring volta



### 6.10.6 E1 connection

For E1 connection at first i have to check the loop test. For loop test the U-LINKs are removed and a loop is given for cross checking the E1 path. After cross checking the E1 path balun are connected in slim rack; which connects to Huawei DDF through a twisted pair cable. The TX of Huawei crone is get connect to RX of slim rack and RX of Huawei DDF get connect to TX of slim rack.



REMOVE THE U-LINK & GIVE A LOOP FOR CROSS CHECKING THE E1 PATH



Give a loop for cross checking the E1 path

Fig-6.22: Loop test



Cross check the E1 path



AFTER CROSS CHECKING E1 PATH CONNECT BALUN

Fig-6.22: Connection of Balun

## Chapter 7

### Planning of Accessories

#### 7.1 Distributed Antenna Systems:

The RBS [1] are usually connected to the mobile operators networks via copper Wires, optical fibers or microwave link connections. The output ports of the RBS are connected to one or several antennas. An antenna system with several antennas is usually named Distributed Antenna System or simply a DAS. Depending on the implementation, the DAS can serve one or several operators and one/or several bands (e.g. GSM 900, GSM 1800 and WCDMA). In some cases the DAS can be used to concurrently distribute both cellular and non-cellular bands, e.g. both GSM and WLAN in one and the same antenna system. The DAS can consist of either passive or active components. When both active and passive components are used in a DAS, it is often referred to as a hybrid solution. Some advantages of a dedicated RBS connected to a distributed antenna system, DAS, are that it is possible to ensure both dedicated coverage and capacity, confine the signals, prevent spillage and interference and thus enhance the quality for both speech and data services. Except for enabling new traffic in previous non-covered areas, the solution also off-loads the macro network in overlapping coverage areas. The RBS are normally owned by mobile operators. DAS consists of either passive or active components or a mix of passive and active components. The passive DAS are the most commonly deployed and consist of coaxial feeder cables and components such as antennas, power tapers and power splitters. Radiating feeders are used as a combined feeder cable and antenna. They are often used in tunnels and culverts. The distributed antenna systems can be implemented in many different ways and some the most frequently used designs are presented.

#### Distributed Antenna System:

- Using passive components like (Splitters 2way, 3way, 4way, Couplers 6dB, 7dB, 10dB, 17dB, 20dB etc.)
- Using Active amplifiers (Line amplifiers etc.)
- Using CAT-7 Cable, Main Hub, Expansion Hub and Remote antenna unit (RAU's) Leaky Cable System: Coupling loss, Attenuation over distance need to be calculated.

## Omni antennas

The Ultra sphere [2] in-building wireless antenna is so surprisingly small in size that can be hidden anywhere, providing an invisible solution for many applications.

The omni direction pattern is suited to a variety of uses such as in-building systems or other applications where mobility is a factor.



Fig.7.1: Omni Antennas

## 7.2 Planning of Accessories Directional or Cell-Max antennas

Cell-Max Antennas [2] feature a multi-band design that allows a wide range of frequencies to be covered by one small antenna. Created primarily for office environments, Cell-max Antennas are also ideally suited for parking garages, airports, shopping malls, and other difficult coverage areas.

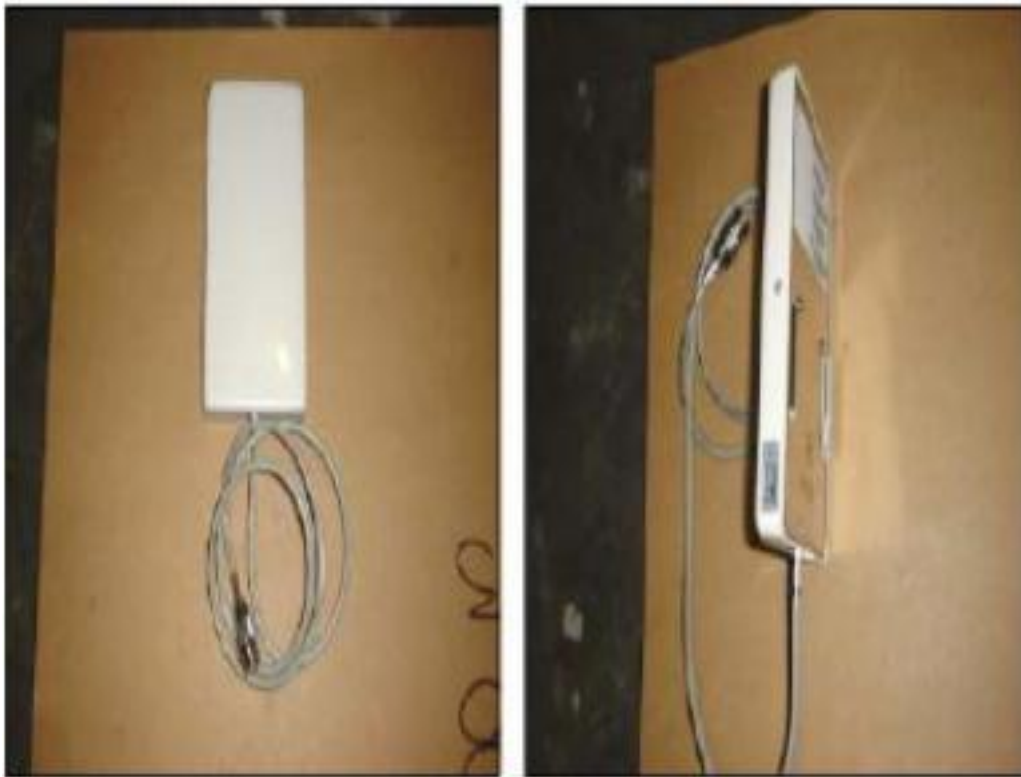

Fig.7.2: Directional or Cell-Max Antennas

### **PRRU:**

LampSite is an industry-leading in-depth radio coverage solution that supports indoor multimode deployment in large- to medium-sized sites such as office buildings, venues, and transportation hubs and semi-enclosed sports stadiums.

A LampSite base station consists of a baseband unit (BBU), Pico Remote Radio Unit (pRRU), and RRU HUB (RRU HUB)





**PRRU**



**Rhub**

### 7.2.1 Antenna Gain

Antenna		Gain
Omni Antenna		+4dB
Cell max or Panel Antenna		+7.7dB

Table 7.1 Antenna Gain

### 7.3 Planning of Accessories Splitters & Couplers



Fig.7.3: Different Type Splitters



Fig.7.4.: 10 dB Coupler

### Passive Distribution Techniques

- Cable lengths more than 70mts has to be a 7/8" (Less loss)
- Use RF couplers for symmetrical power splits
- Coupler values are 3dB, 7dB, 6dB, 7dB, 10dB, 17dB, 20dB & Variable couplers
- Design must have similar power distribution & coupling loss to each antenna
- Best design is to minimize the co-ax length as far as possible.

### Feeder cable Loss

Cable	Loss
1/2" per meter	0.1
7/8" per meter	0.06

Table 7.2: Feeder cable Loss per meter

## Coupler Loss

<b>Couplers power</b>	<b>Throughput</b>	<b>Coupling put</b>
<b>7 dB</b>	<b>1.7 dB</b>	<b>7 dB</b>
<b>7 dB</b>	<b>1.7 dB</b>	<b>7 dB</b>
<b>10 dB</b>	<b>.7 dB</b>	<b>10 dB</b>
<b>17 dB</b>	<b>.2 dB</b>	<b>17 dB</b>

**Table 7.3: Different type coupler Loss**

## Splitter Loss

<b>Splitter power</b>		<b>Loss</b>	
<b>2 way</b>		<b>3 dB</b>	
<b>3 way</b>		<b>7 dB</b>	
<b>4 way</b>		<b>6 dB</b>	

**Table 7.4: Different type Splitter Loss**

## Chapter 8

### Planning of Accessories

#### 8.1 Introduction

The RF power [4] budget for an indoor antenna system is calculated in exactly the same manner as for an outdoor system. A passive cable distributed multiple antenna system is limited in extent by the RF power budget. The maximum power available to each antenna from the RF Head, and the power presented to the RF Head from mobiles, is subject to the attenuation of the cable distributed antenna system. This is usually found to be more problematic with the down link as the Power Amplifier (PA) output from the RF Head is divided among multiple antennas on a continuous basis. It therefore suffers the combined effect of the cable loss, power dividing loss, and the insertion loss associated with each power divider in the path to the RF Head. The power radiated from the mobile need only be received by one antenna, and is subject only to the insertion loss associated with each power divider in the path to the RF Head (in addition to the cable loss).

#### 8.2 RF power and Link Budget

Link budget of indoor cells can be obtained by same way with the link budget of outdoor macro cell

##### 8.2.1 The signal strength required

The signal [5] strength required In order for communication to take place pad condition actually it is some margin should be added at MS level of sensitivity such as Rayleigh fading interference and loss of body. So that the signal strength (SSreq ) Can be calculated according to equation:

$SS_{req} = MS_{sen} + RF_{marg} + IF_{marg} + BL$  With:

$MS_{sens} = MS_{sensitivity} \text{ (dB m)}$

$RF_{marg} = \text{Rayleigh fading margin (dB)}$

$BL = L_{ss \text{ body}} \text{ (dB)}$

## 8.2.2 BTS Power output

Calculation of [5] power output BTS which will create a balanced system for all types of power class MS, in order to get equation

$$P_{out\ bale} = P_{out\ MS} + D_s$$

With:  $P_{out\ bale}$  = Transmitter MS Power (dBm)

$D_s$  = MS sens – BTS sens (dBm)

$D_s$  is the difference of BTS and MS receiver sensitivity

## 8.2.3 Radiated EIRP (Effective Isotropic Power)

$EIRP = P_{out\ bale} - (L_{dupl\ BTS}) - L_f\ BTS + G_a\ BTS$  With:

$P_{out\ bale}$  = Power output is balanced (dBm)

$L_{dupl\ BTS}$  = Loss duplexer on the BTS (dB)

$L_f\ BTS$  = Loss liaison and jumpers on BTS (dB)

$G_a\ BTS$  = Gain of the BTS antenna (dBi)

## 8.3 Link Budget Element of a GSM Network

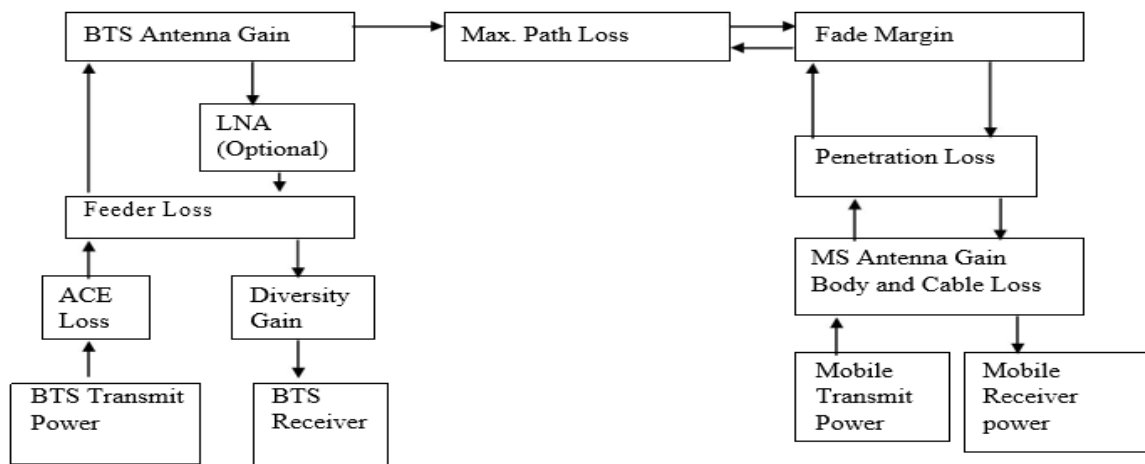

Fig:8.1 Link Budget Element of a GSM Network

## 8.4 Link Budget

### BTS Transmit Power

- Maximum [4] transmit power
- GSM900 and 1800 networks use radios with 48dBm maximum transmit power

### ACE Loss

- Includes all [4] diplexers, combiners and connectors
- Depends on the ACE configuration
- The ACE configuration depends on the number of TRXs and combiners

No of TRxs	Network	AEC Configuration	Downlink Loss(dB)
1 or 2	GSM900	2 Antennas per cell, diplexer	1.0
1 or 2	GSM1800	2 Antennas per cell, diplexer	1.2
3 or 4	GSM900	2 Antennas per cell, diplexer + hybrid combiner	4.4
3 or 4	GSM1800	2 Antennas per cell, diplexer + hybrid combiner	4.4

Table 8.1: ACE configuration table [5]

## 8.5 Mobile Receiver Sensitivity

- [4] The sensitivity of GSM900 and GSM1800 mobile = -102 dBm
- The following should be noted: -
  - ❖ The sensitivity level is not sufficient to achieve RXQUAL of 4 without frequency hopping RXQUAL of 5 with frequency hopping
- A mobile receiver that moves at 50km/h averages the fading, but a static one will be under more severe fading influences. Therefore: -
  - ❖ If the quality of a static mobile needs to be considered, then a quality margin of approximately 4 - 5 dB is used
  - ❖ The mobile sensitivity would be -97 or -98 dBm.

## Chapter 9

### Acceptance Testing and Commissioning part

#### 9.1 Materials or Accessories Check

- Physically check [2] the implementation (any loose cabling, physical damage on feeders, antennas Clamped properly etc.)
- VSWR check for sample cables (it is highly impossible to check VSWR for each cable in building Solution, the reason is we have more than 100 pieces of cable in an average building, testing all the 100 will fetch entire 2 days & more over some cables will be inside the false ceiling )
- Check the list of inventory's used in that particular site
- Sample check the implemented cable lengths (Checking all the feeder physically might not be Possible)

#### 9.2 Electrical & Ground Check

- Check the [2] power connections of Micro BTS (Voltage check, Grounding, Fixing etc.)
- Feeder cable connected to the output of micro cell has to be grounded properly using grounding kit
- Ventilation in the room to be checked

#### 9.3 RF Signal Check

- Check the [2] signal levels (Idle mode) at places mentioned in the RNP report
- Check Call Setup, Call quality, Call sustain and Call hand over to Outdoor cells. Available from:



## 9.4 Antenna and RBS System – Overview

When designing [6] an indoor system, the ambition is (note! this is not a requirement) to get the antenna network as symmetric as possible in order to provide each single antenna within the system with the same output power. It is desirable to place the RBS somewhere in the middle of the building in order to minimize feeder distance to the antennas.

Preparation for any future extension of the indoor system, both from a coverage point of view and from a capacity point of view, shall always be considered before the installation. The RF link budget shall be calculated so that there is a possibility to add power splitters, hybrid couplers, etc. to the antenna system in case of further extension of the antenna network.

Although if the intention is, when planning an indoor system, to be operating on a GSM frequency single-band, it's better to prepare the antenna network for multi-band. The cost of investing in multi-band equipment is marginal compared to what it would cost in the future to replace the single-band equipment with multi-band equipment.

In an indoor cell, the downlink is usually the most critical link in the air-interface. This means that there is no need for using uplink diversity in an indoor system or to use amplifiers for improving the uplink signal.

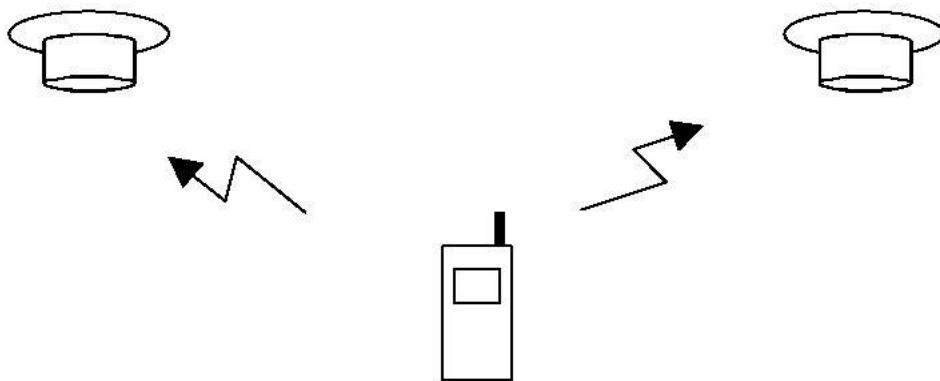

Fig.9.1: Omni Antenna connect to mobile signal (uplink)

## 9.5 Commissioning part step to step

### Software commissioning

For login in Huawei BTS; BTS have to connect with laptop through CAT-5 cable. This login cable get connects in ETH port of BBU. Huawei BTSM software are used for commissioning. After loading software i have to check the version of all board. The version is V100R012CooSP311. The process of loading software is given below;

Commissioning steps:

- Site management right
- Super password
- Forced software load for GTMU
- Software activation for GTMU
- Set site type
- Add cabinet
- Forced software load for UBRI
- Software activation for UBRI
- Forced software load for MRFU
- Software activation for MRFU

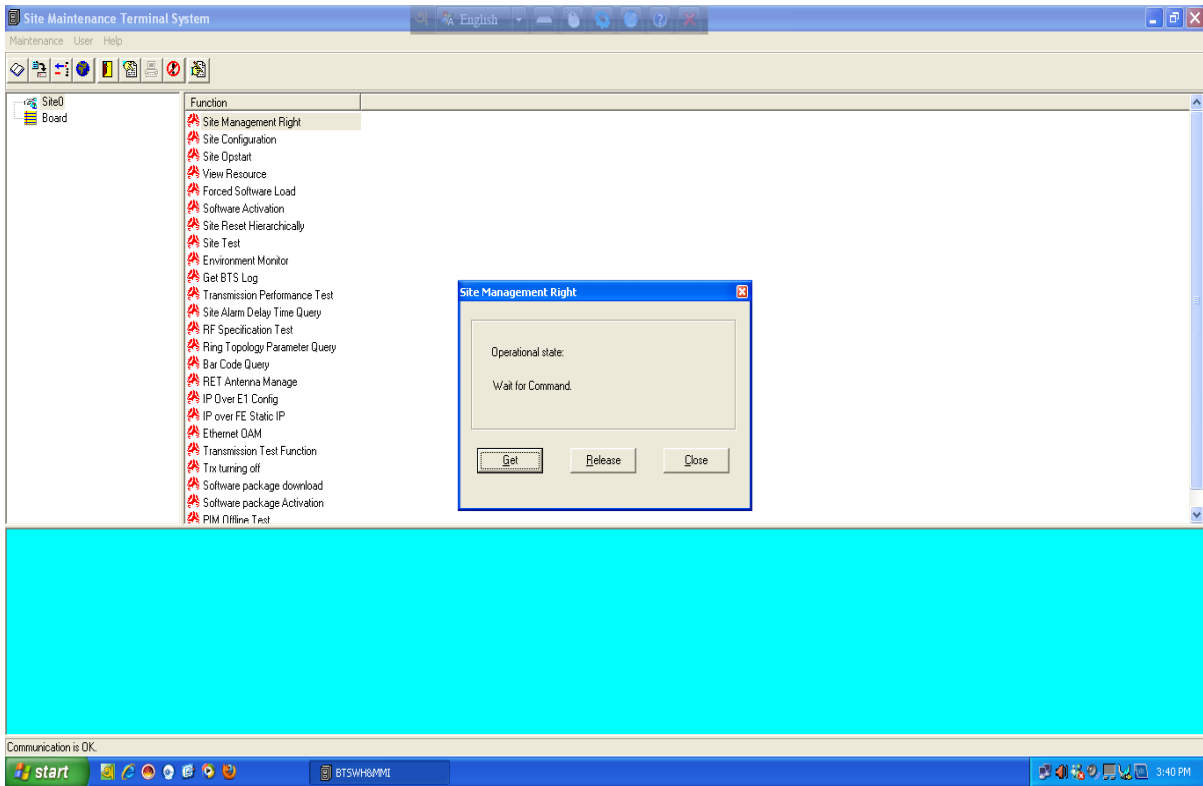

Fig-9.2: Site management right

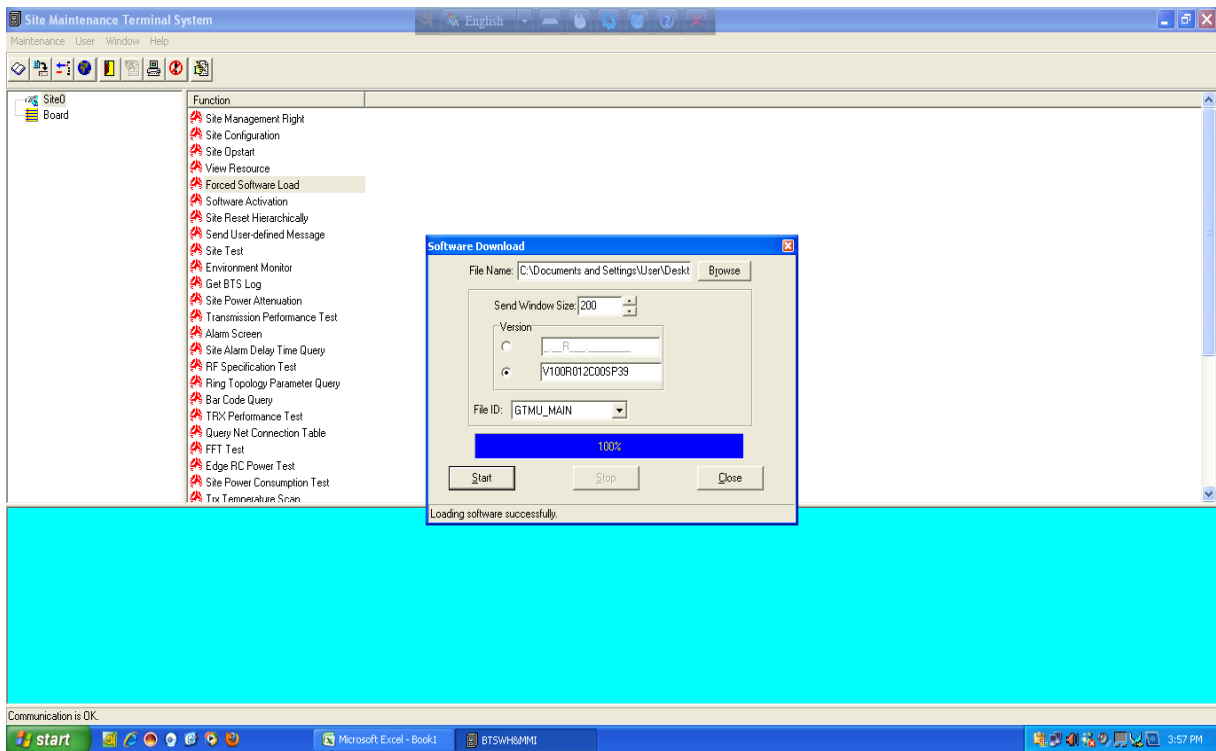

Fig-9.3: Forced software load for GTMU

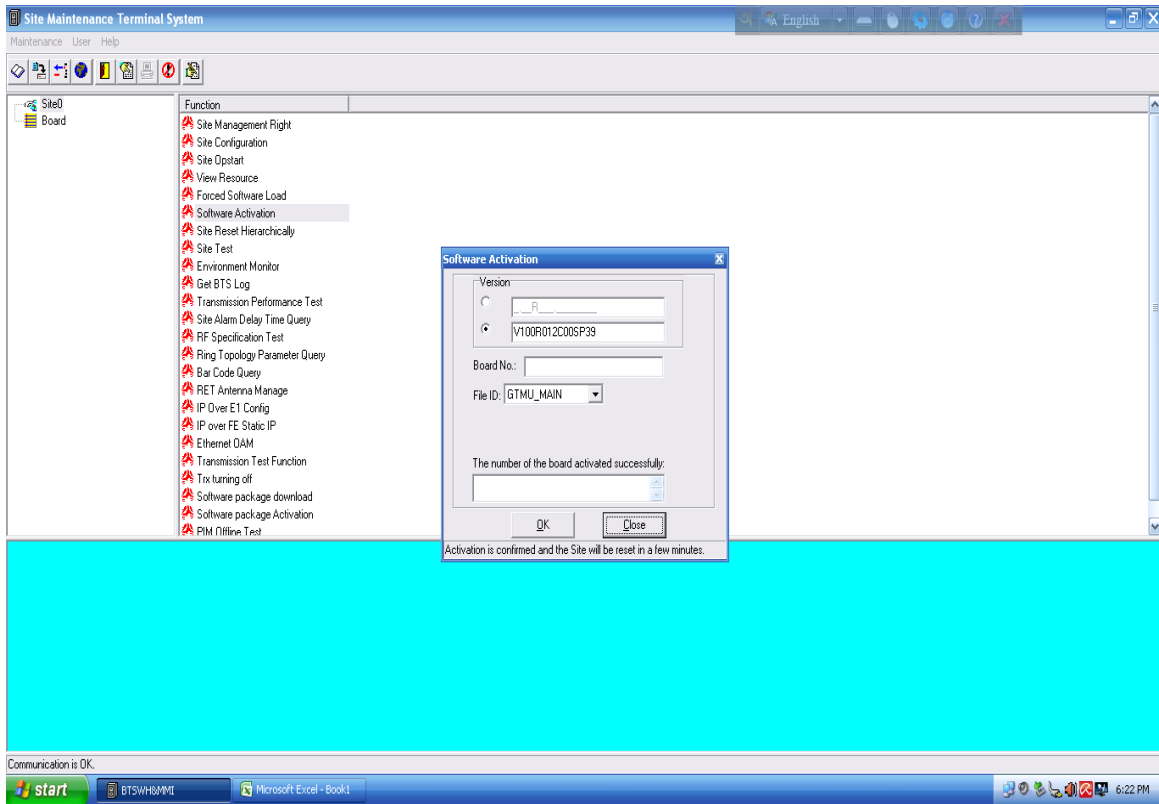

Fig-9.4: GTMU software activation

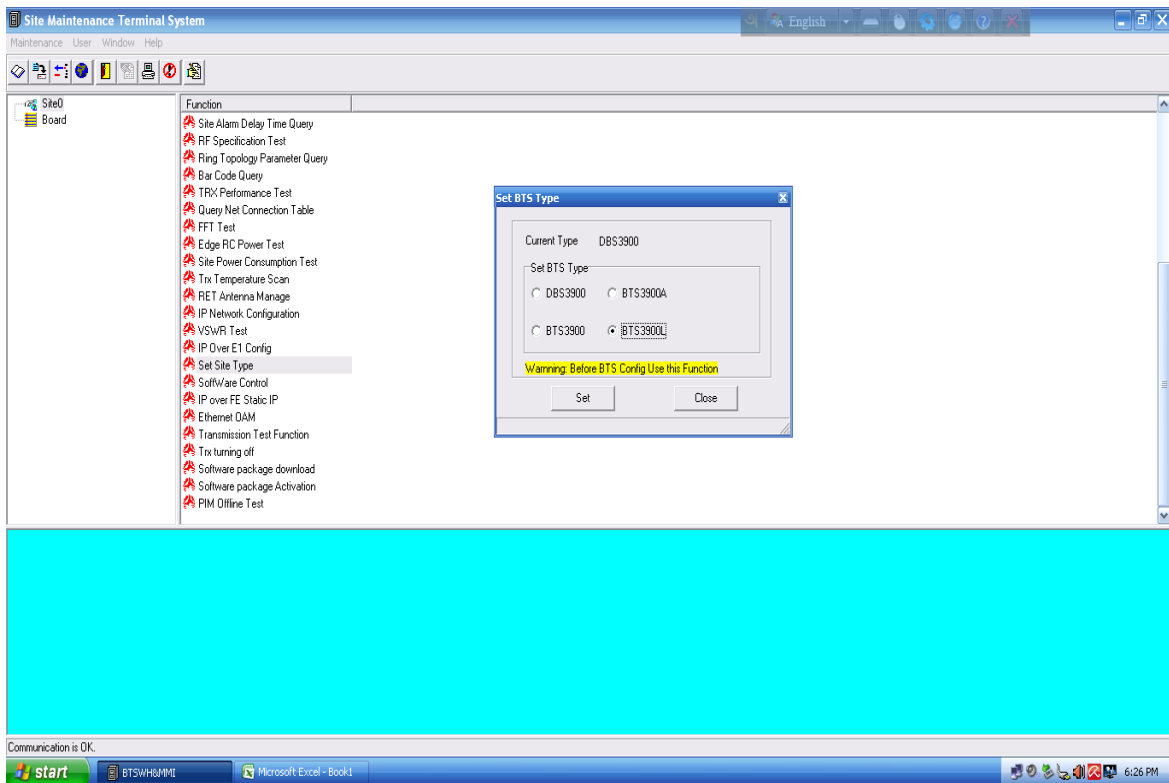

Fig-9.5: Set site type

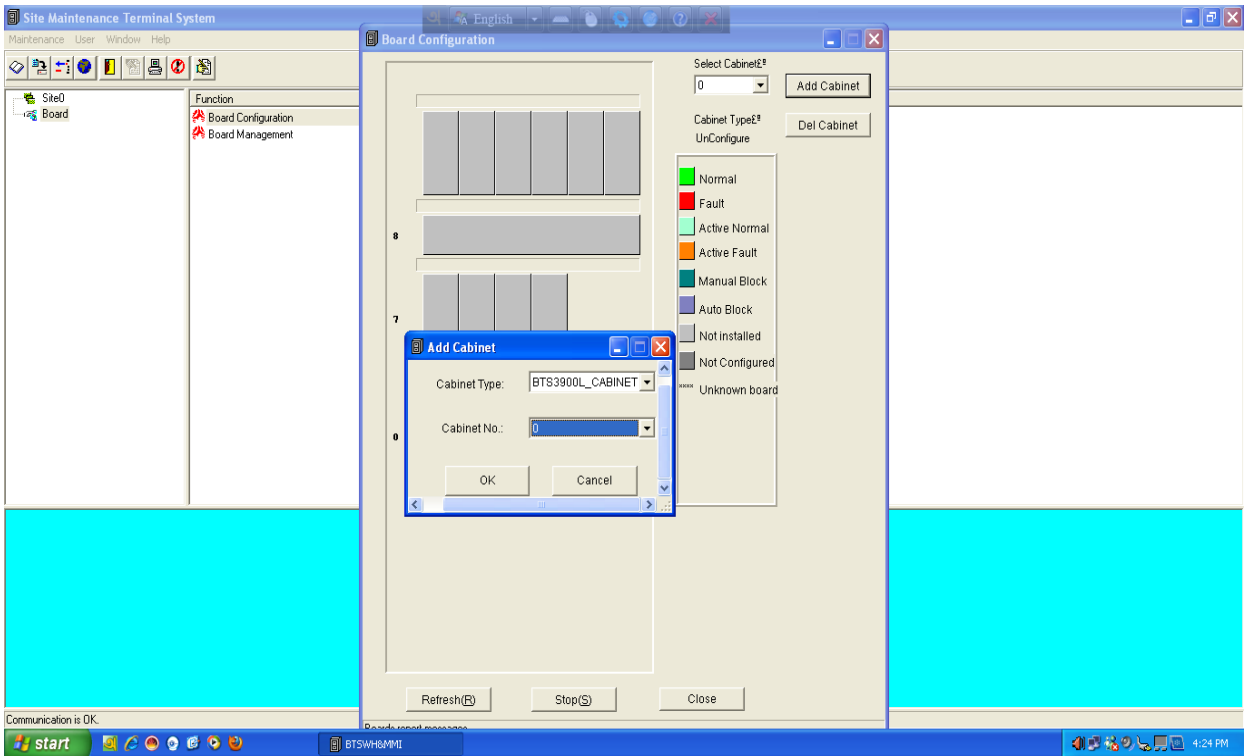

Fig-9.6: Add cabinet

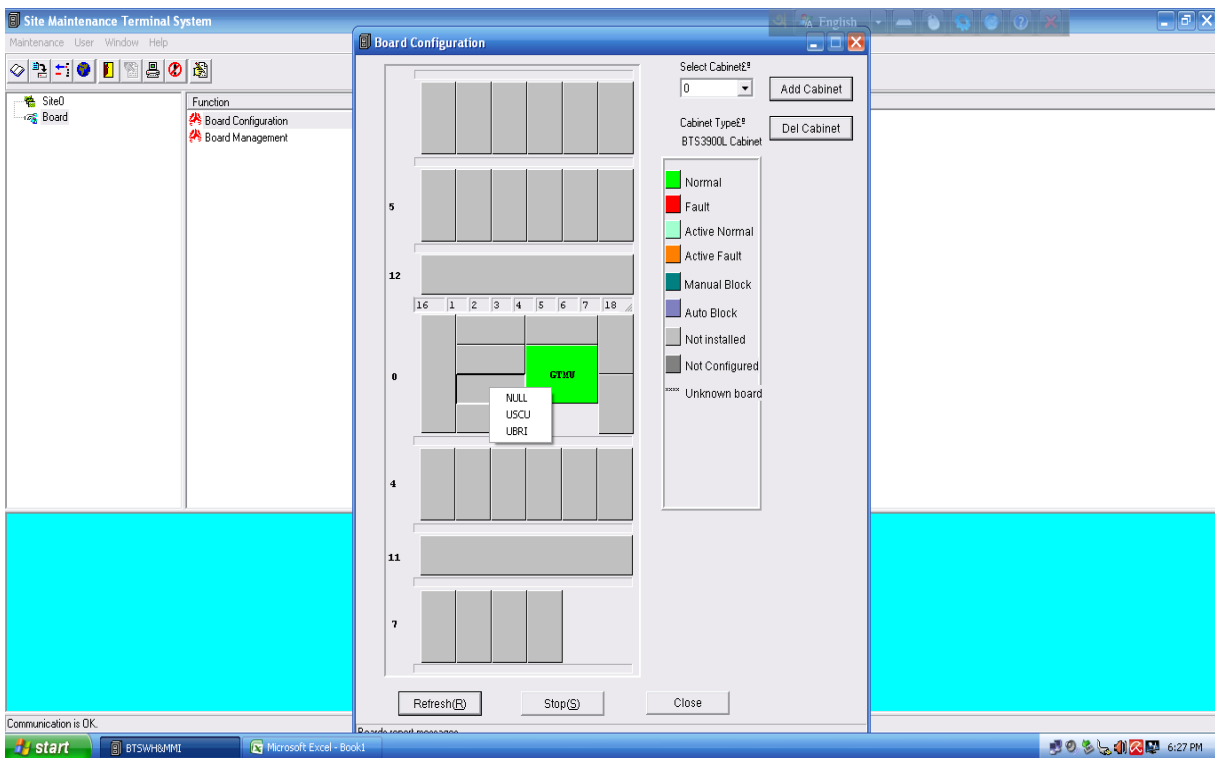

Fig-9.7: Add UBRI from board configuration

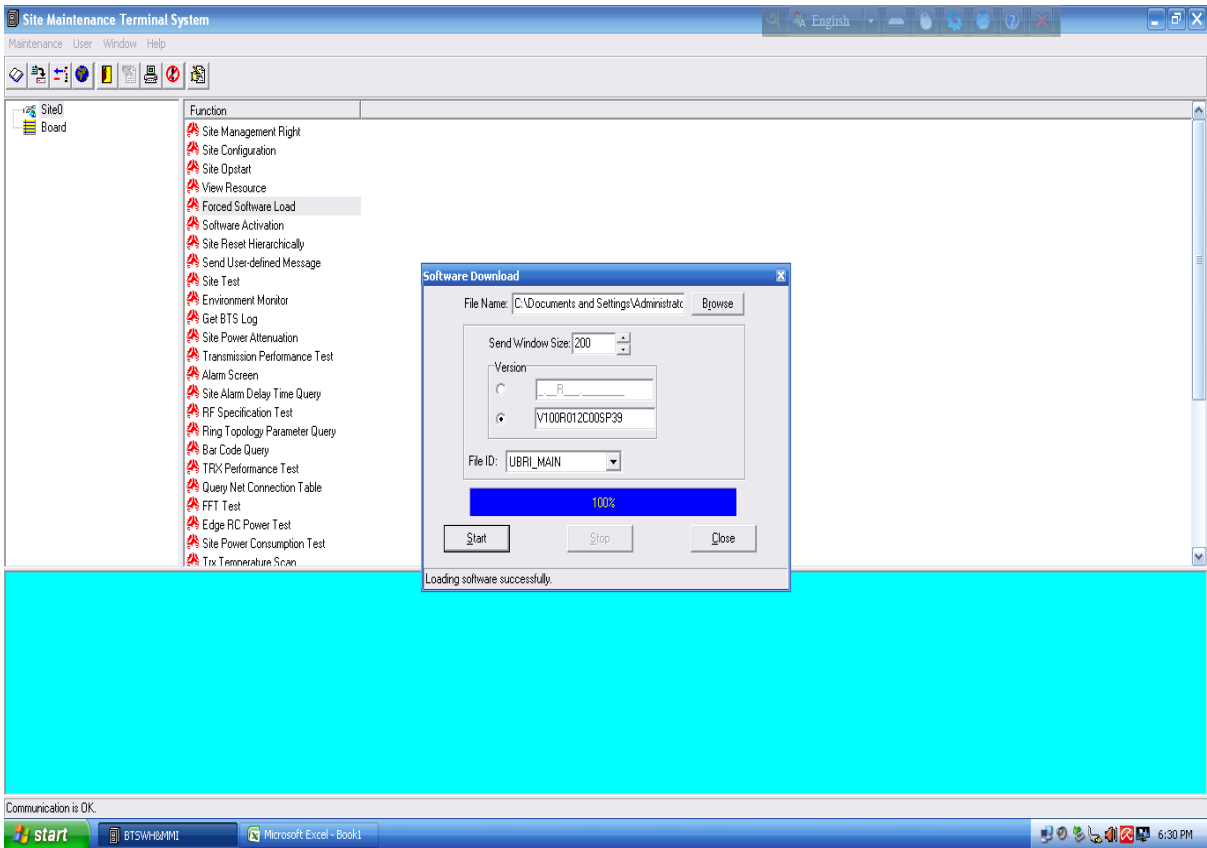

Fig-9.8: Software load for UBRI

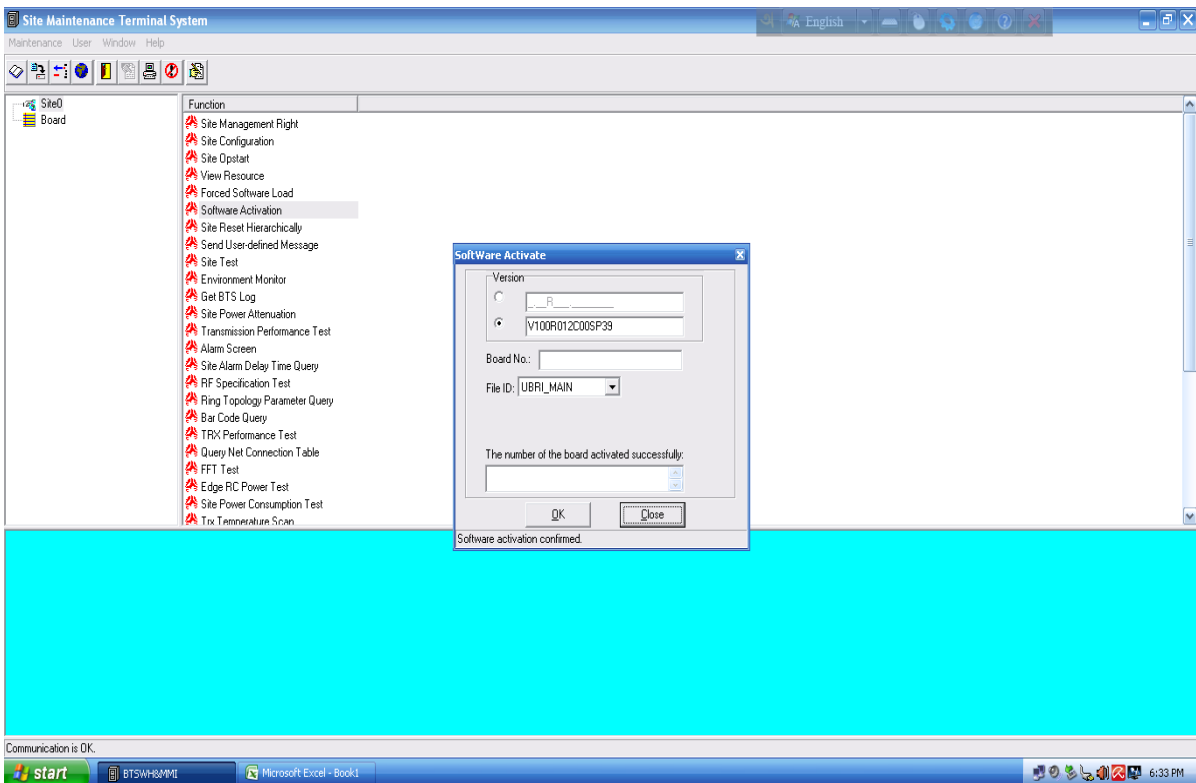

Fig-9.9: Software activation for UBRI

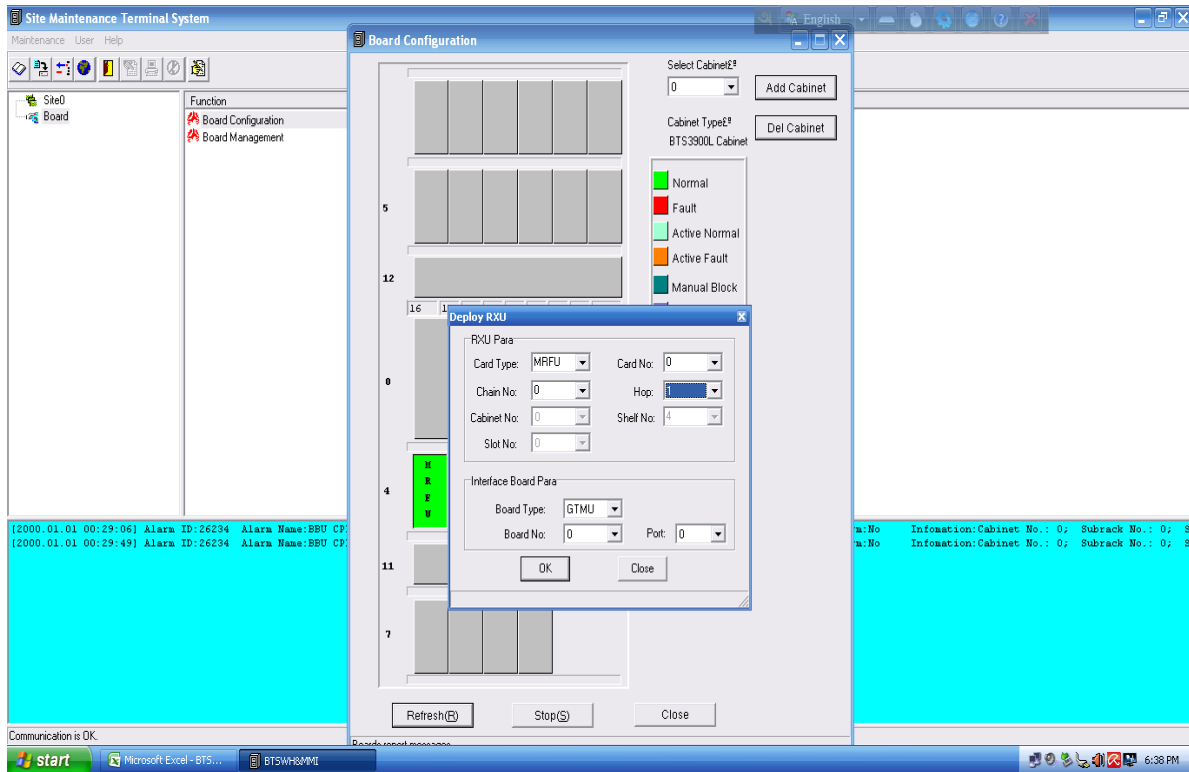

Fig-9.10: Adding MRFU for 190

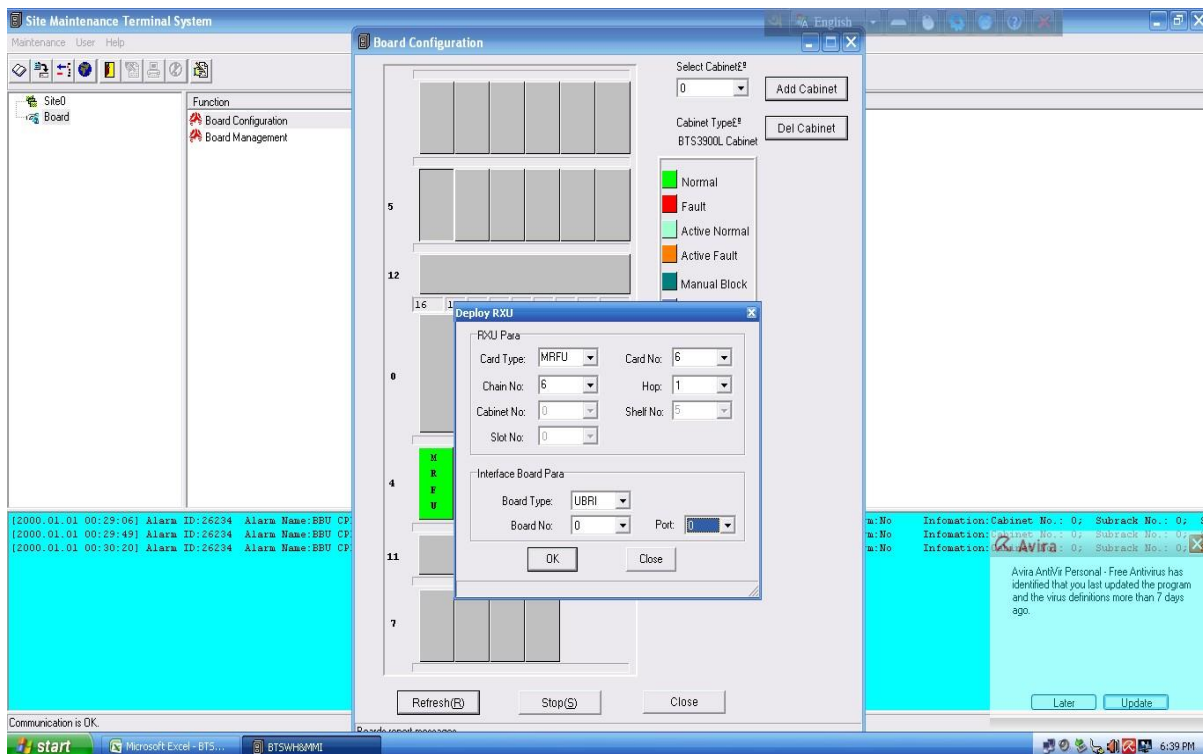

Fig-9.11: Adding MRFU for 1800

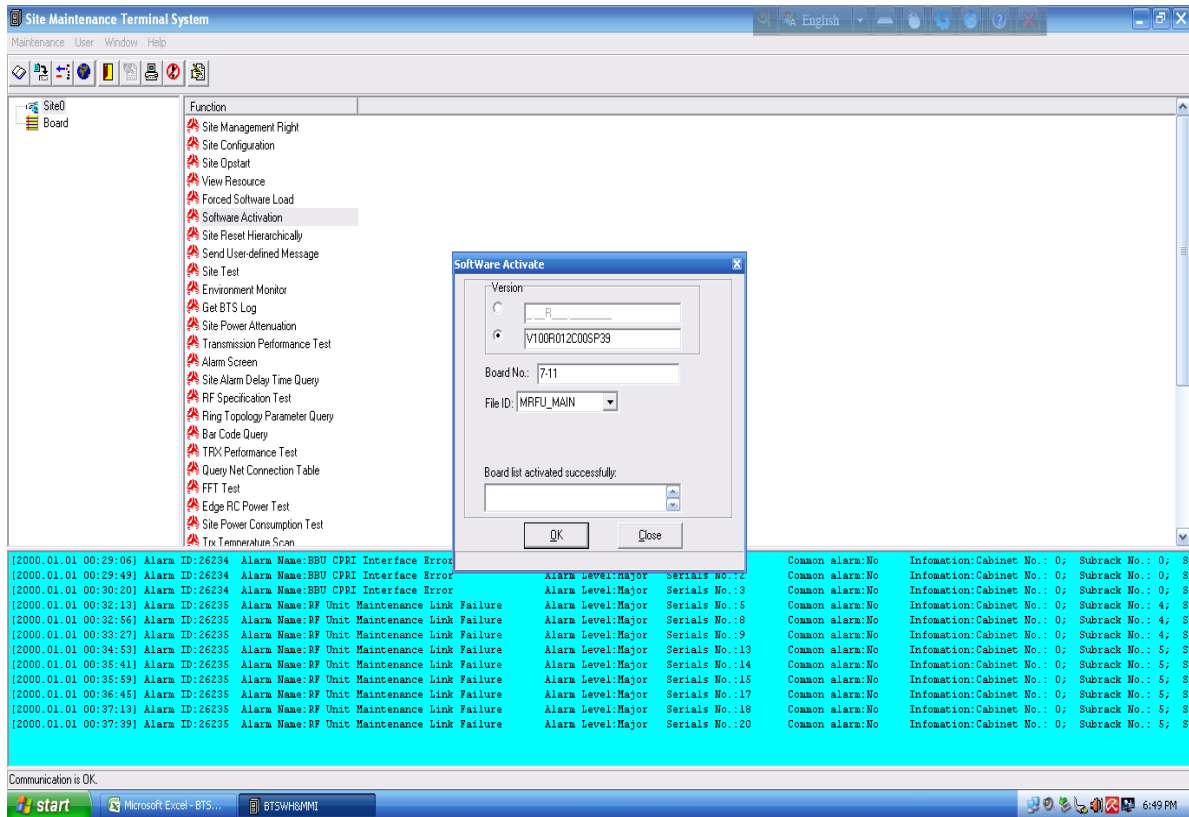

Fig-9.12: MRFU software load

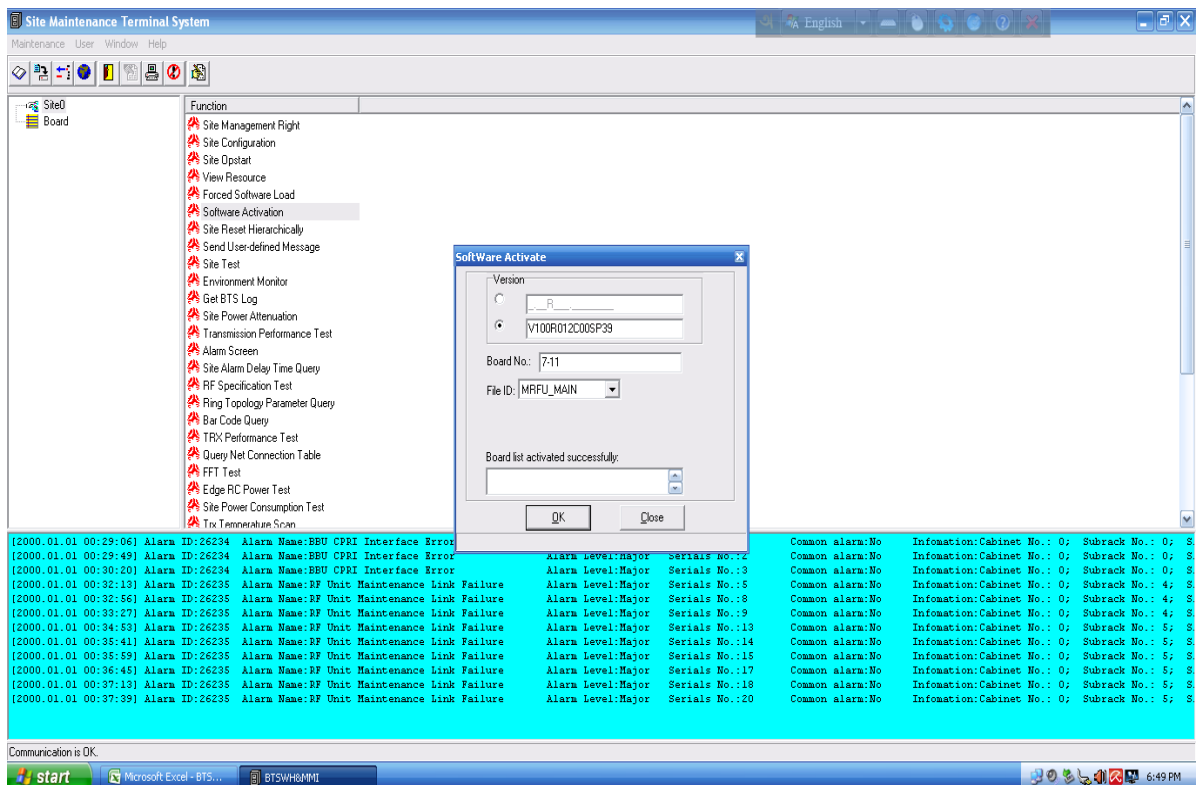

Fig-9.13 Software activation for MRFU



## 9.6 Creating alarm

In BTS room GP use 9 alarms which maintains a sequence according to GP standard. The alarm sequence is given below:

1. Temperature alarm
2. Mains Fail
3. Battery disconnected
4. Rectifier Module Fail
5. Aviation light
6. Generator running
7. Fuel level low
8. Water level high
9. Door open
10. AG Door open

The procedures of creating these alarms are given below:

**Temperature alarm:** Current temperature and humidity can be assumed by OMC from environment monitoring option. Compare the temperature (that you got by OMC software) with the temperature indicated in thermometer. If comparison result is OK then the sensor is OK. Set temperature and humidity much lower than the current temp. And humidity, over temperature and over humidity alarm will be activated. Now set the temperature at the threshold value, over temp. alarm will be deactivated.

**Mains Fail:** If the switch off the MCB from the rectifier or from the DB the mains fail alarm will be activated. If switch is ON the MCB the alarm will be deactivated.

**Battery disconnected:** For Single set battery; have to switch off the Battery bank breaker then battery disconnected pre-alarm will be activated. For Double set Battery If switch off any of the two Battery bank breaker then battery disconnected pre-alarm will be activated. When breaker is on Battery disconnected pre-alarm will be deactivated.

**Rectifier Module Fail :** In case of BSMC rectifier if the module is pull out from its slot module fail alarm will be activated. Push the module in the slot again, alarm will be deactivated. In case of ELTEK Rectifier have to stop the module FAN by inserting a tie, then rectifier module fail will be activated. If the tie is pull out then alarm will be deactivated. In case of DELTA/ASCOM switch off the breaker of the module, alarm will be activated. If switch is ON the breaker alarm will be deactivated.

**Aviation Light Failure:** First i have to cover the sensor by black tape. It'll show “90% light on” on the aviation light controller display. Now have to press the alarm test/fault test button, then display will show “50% light on” and there will be a continuous beep. After few time Aviation light failure alarm activated. Aviation light failure alarm will be deactivated automatically.

**Generator Running:** First i have to choose Manual option on the generator display board. To get generator running alarm have to switch off the generator circuit Breaker manually, Generator running alarm will be deactivated. If switch is ON the generator manually, generator running alarm will be activated.

**Fuel Level Low:** If the sensor is pulling out from the fuel, alarm will be activated. If the sensor is put again inside the fuel alarm will be deactivated. If there are two generators, any generator's Fuel Level is low, alarm will be activated.

**Water Level High:** If the sensor pull up a bit higher, alarm will be activated. If put it down to its previous position, alarm will be deactivated.

**Door Open:** If the door is open, Door open alarm will be activated. If the door is closed, Alarm will be deactivated.

**Door AG:** Same as BTS door open alarm.

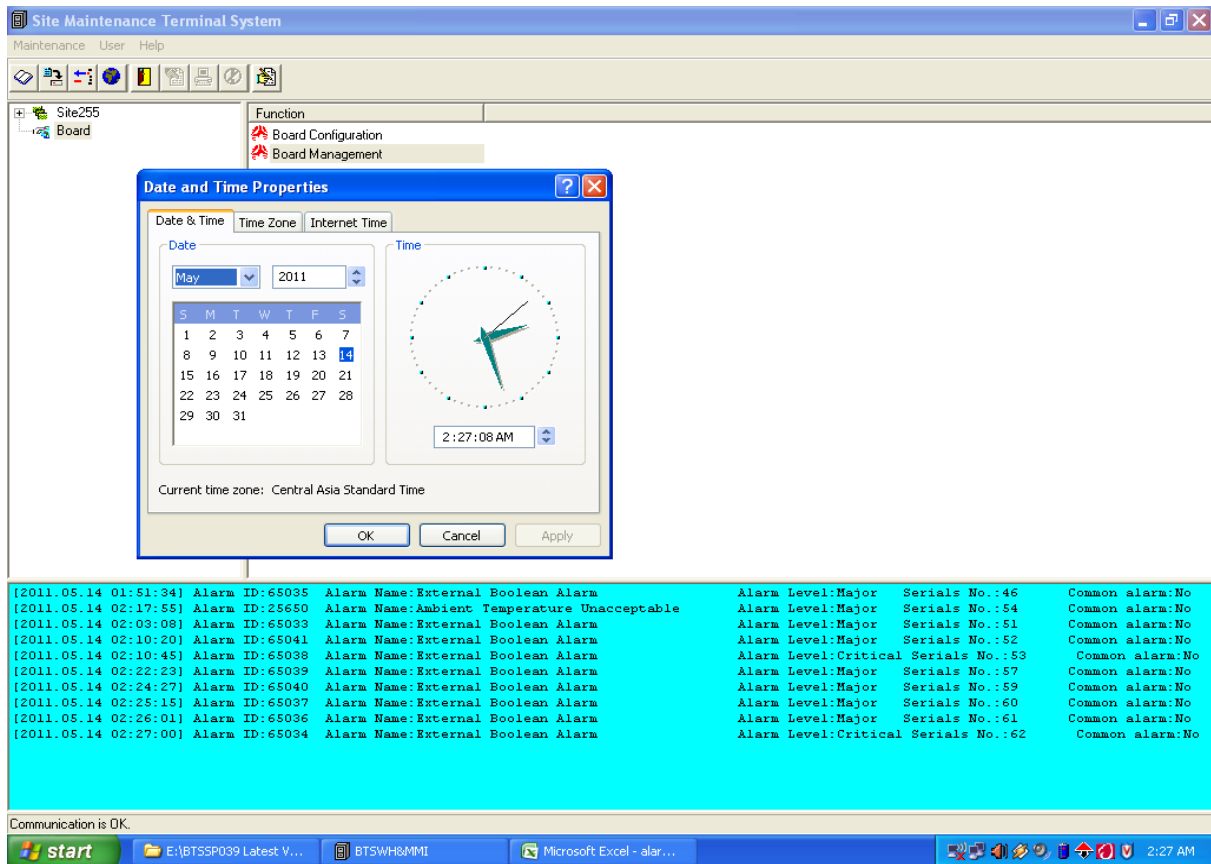

Fig-9.14: creating and removing alarm

## 9.7 VSWR

In telecommunications, **standing wave ratio (SWR)** is the ratio of the amplitude of a partial standing wave at an antinodes (maximum) to the amplitude at an adjacent node (minimum), in an electrical transmission line. The SWR is usually defined as a voltage ratio called the **VSWR**, for *voltage standing wave ratio*. Vswr can be checked in BTSM software or in Site Master. Normally it is checked in BTSM software. The value of VSWR must be under the range of 1.4 in both TX and RX end. If it is higher then 1.4, then required connector have to make again.

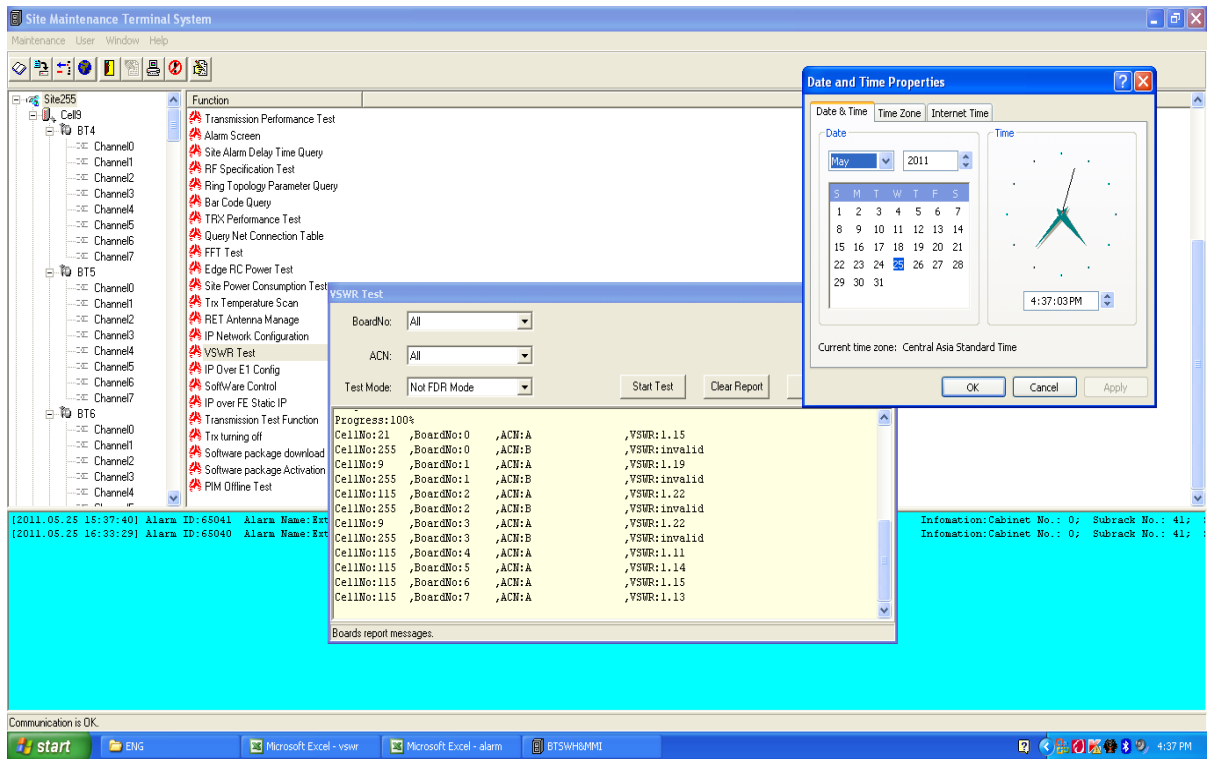

Fig-9.15: VSWR on TX

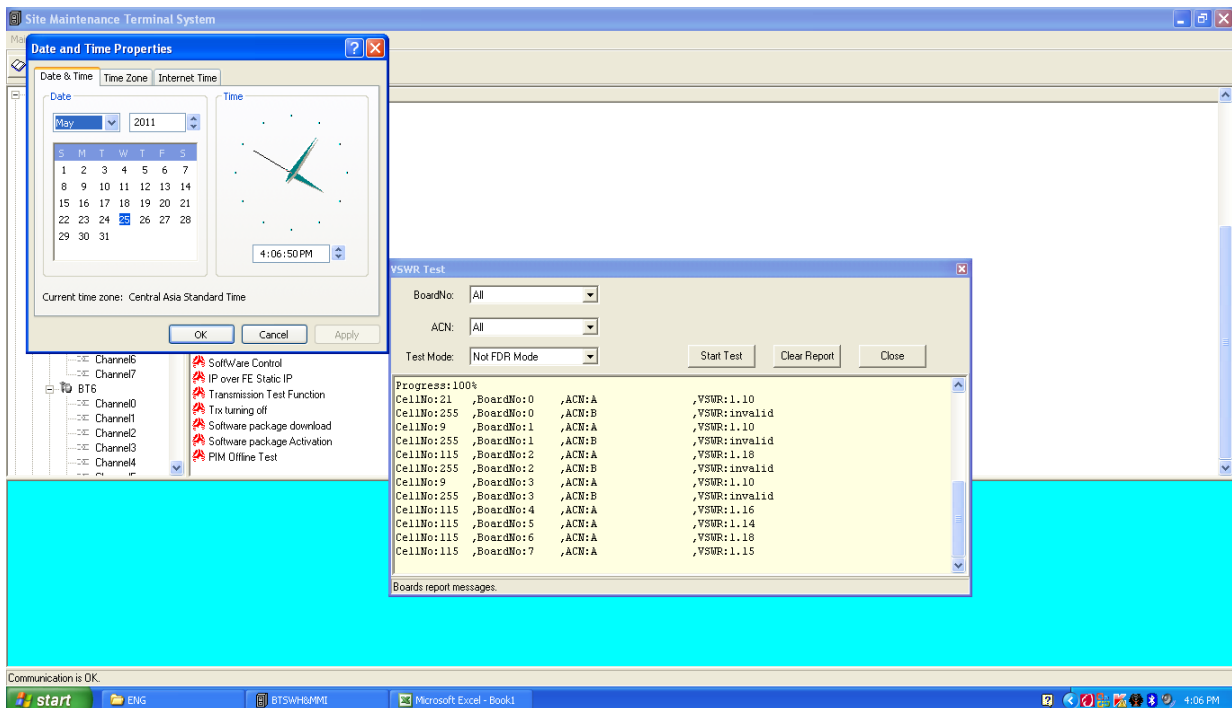

Fig-9.16: VSWR on RX

## 9.8 Call Test

For call test need an mobile with NET MONITOR software which supports only in symbian mobile phones. For login and exit this software need an password and password is – 0101 for login and 0000 for exit. At page number 11 shows the Cell ID, BCCH, and LAC. At page number 3, 4, 5 shows neighboring cell, and at first page shows forward power. For call test at first have to call NM by moving from Cell to Cell.

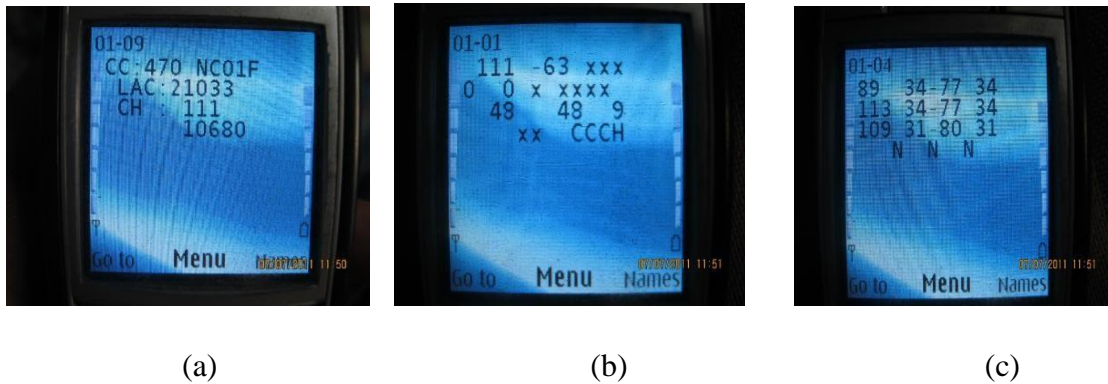

Fig-4.16: (a) Cell ID; LAC.CH (b) Forward power (c) neighboring channel

From this picture it assume that here the Cell Id is 10680; Channel is 111; Location area code 21033; forward power of the channel is -63; and neighboring channels are 811, 113, 1011.

## 9.9 PAT documents

PAT documents are that kind of document which bear all of the information about the site and this document have to fill up very carefully. These documents are consists of survey report, GSM plan, room layout, BTS configuration, Mark able asset checklist, basic functionality test report, return asset check list, preliminary acceptance test report

Operators cannot ignore the importance and advantages of providing dedicated in-building coverage GSM system. Users who try new indoor coverage services expect them to exceed existing services in every respect. Besides, providing excellent local In-building coverage, dedicated in-building systems for in-building coverage GSM-based networks greatly offload the part of the mobile network. Therefore, they give operators a cost-effective way of catering for new subscriber growth. In all likelihood, distributed antenna systems will dominate as the preferred solution for providing in-building coverage

## **Chapter 10**

### **Conclusion**

#### **10.1 Conclusion**

The conclusion for this part is with In Building Coverage technology it will help people to use the hand portable such cell phone to receive or make a call anywhere and anytime freely even in basement without thinking that the transmission will terminated.

In-building solutions are well-proven methods for an operator to capture new traffic and new revenue streams. One can provide enhanced in-building solutions to off-load the macro network, thus increasing mobile traffic, and attract additional subscribers due to the enhanced mobile network quality and accessibility to mobile Internet applications and other services that require high data-rates and capacity.

There are several different ways to implement in-building solutions. Dedicated Radio Base Stations, RBSs, that are connected to Distributed Antenna Systems, DASs, are commonly implemented solutions. These solutions provide additional capacity as well as covers —black holes inside different kinds of buildings. A number of different types of both RBSs and DASs are available and the solutions can be customized for different buildings and needs.

## REFERENCE

- [1] Wireless networks for in building environments|| White Paper of Ericson, 284 23-3026 Uen Rev A, April 2005[Accessed Time: 11:45 AM 13-Nov-18]
- [2] KULASEKARAN. P, Technical Specialist - RF (In-building Radio Network Planner) Bangalore. (INDIA), —In building coverage solution||12/13/2005. [Cited 2010 06<sup>th</sup> September]; Available in: <http://www.rfcafe.com/references/articles/IBS-Presentation-Kulashekar.pdf>[Accessed Time: 1:23 AM 15-Nov-18]
- [3] Indoor Coverage Systems for GSM Networks RF Engineering Guideline|| Lucent Technologies (Bell Labs Innovations), EG: GSMIDC, 401-380-363, Issue 2.0.June 2000[Accessed Time: 9:53 PM 23-Nov-18]
- [4] GSM Systems RF Network Design [Cited 2010 07<sup>th</sup> October]; Available in:<http://m2vtelecom.files.wordpress.com/2008/02/gsm-training-2.pdf>[Accessed Time: 1:00 AM 29-Nov-18]
- [5] Harry Rachmawan (L2F002581), Department of Electrical Engineering Faculty of Engineering, Diponegoro University, Semarang —IBC COVERAGE SIMULATION SYSTEM (*IN- BUILDING Coverage*)” 11 Jan 2011[Accessed Time: 9:00 AM 1-Dec-18]
- [6] GSM CELL PLANNING WORKSHOP|| Ericsson, STUDENT TEXT, EN/LZT 123 3315, R3B, 15/05/1999[Accessed Time: 12:01 AM 3-Dec-18]
- [7] Project of Obontika colortex a building project, Date on 29-08-2018[Accessed Time: 9:00 AM 16-Dec-18]







