

**INTERNSHIP IN NETWORK ENGINEERING OF SOFTSWITCH AND  
PHONES AT BTCL**

**BY**

**ABUL BASHAR**

**ID: 201-15-13966**

This Report Presented in Partial Fulfillment of the Requirements for the  
Degree of Bachelor of Science in Computer Science and Engineering

Supervised By

**Md. Firoz Hasan**

Lecturer

Department of CSE

Daffodil International University

Co-Supervised By

**Tanzina Afroz Rimi**

Lecturer

Department of CSE

Daffodil International University



**DAFFODIL INTERNATIONAL UNIVERSITY**

**DHAKA, BANGLADESH**

**DECEMBER 2022**

## APPROVAL

This internship titled “**Internship in network engineering of softswitch and phones at BTCL**”, submitted by **Abul Bashar**, ID No: **201-15-13966** to the Department of Computer Science and Engineering, Daffodil International University has been accepted as satisfactory for the partial fulfillment of the requirements for the degree of B.Sc. in Computer Science and Engineering and approved as to its style and contents. The presentation has been held on 19 December, 2023.

### BOARD OF EXAMINERS

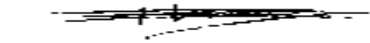

**Dr. Touhid Bhuiyan**  
**Professor and Head**

Department of Computer Science and Engineering  
Faculty of Science & Information Technology  
Daffodil International University

**Chairman**



**Naznin Sultana**  
**Associate Professor**

Department of Computer Science and Engineering  
Faculty of Science & Information Technology  
Daffodil International University

**Internal Examiner**



**Abdus Sattar**  
**Assistant Professor**

Department of Computer Science and Engineering  
Faculty of Science & Information Technology  
Daffodil International University

**Internal Examiner**



**Dr. Md. Sazzadur Rahman**  
**Associate Professor**

Institute of Information Technology  
Jahangirnagar University

**External Examiner**

## DECLARATION

We hereby declare that, this project has been done by us under the supervision of **Md. Firoz Hasan, Lecturer, Department of CSE** Daffodil International University. We also declare that neither this project nor any part of this project has been submitted elsewhere for award of any degree or diploma.

**Supervised by:**

  
18.01.23

---

**Md. Firoz Hasan**

**Lecturer**

Department of Computer Science and Engineering  
Daffodil International University

**Co-Supervised By**

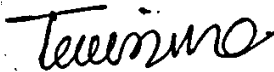

---

**Tanzina Afroz Rimi**

**Lecturer**

Department of CSE  
Daffodil International University

**Submitted by:**



---

**(Abul Bashar)**

**ID: 201-15-13966**

Department of Computer Science and Engineering  
Daffodil International University

## ACKNOWLEDGEMENT

First, we express our heartiest thanks and gratefulness to almighty God for His divine blessing makes us possible to complete the final year project/internship successfully.

We really grateful and wish our profound our indebtedness to **Md. Firoyz Hasan, Lecturer**, Department of CSE Daffodil International University, Dhaka. Deep Knowledge & keen interest of our supervisor in the field of “*Networking*” to carry out this project. His endless patience, scholarly guidance, continual encouragement, constant and energetic supervision, constructive criticism, valuable advice, reading many inferior draft and correcting them at all stage have made it possible to complete this project.

We would like to express our heartiest gratitude to **Dr. Touhid Bhuiyan** Head, Department of CSE, for his kind help to finish our project and also to other faculty member and the staff of CSE department of Daffodil International University.

We would like to thank our entire course mate in Daffodil International University, who took part in this discuss while completing the course work.

Finally, we must acknowledge with due respect the constant support and patients of our parents.

## **ABSTRACT**

BTCL operates many services such as the PSTN, IGW, IIG, ICX, ISP, NGN, and is a CC Domain Registrar in addition to being a voice carrier (.BD). All the services operated in IMS Soft-switch control by BTCL. Nearly all of the copper, fiber optic, and microwave networks in the nation are owned and run by BTCL. In 1853, the BTCL's Post and Telegraph Division was founded. As of right present, the government owns all of BTCL. Landline telephone service is one of the most important services provided by BTCL. There are numerous services offered, including dial-up, ADSL, high-bandwidth local and international leased lines, VPN, MPLS, country domain (.bd), co-location, and others. Soft switch services and triple play on fiber at home will soon be offered by NGN. After finishing a four-month internship at Bangladesh Telecommunications Company Limited, after finishing a four-month internship at Bangladesh Telecommunications Company Limited, I composed this essay, through this internship program, I was able to get knowledge about a telecoms company's daily operations. This article places a strong emphasis on my insights and experience in the company.

# TABLE OF CONTENTS

<b>CONTENTS</b>	<b>Page No</b>
Board of Examiners	<b>i</b>
Declaration	<b>iii</b>
Acknowledgements	<b>vi</b>
Abstract	<b>v</b>
Table of Contents	<b>vi</b>
List of Figures	<b>ix</b>
<b>CHAPTER 1: INTRODUCTION</b>	<b>1-2</b>
1.1 Introduction	<b>1</b>
1.2 Motivation	<b>1</b>
1.3 Objective	<b>1</b>
1.4 About the company	<b>2</b>
1.5 Outcome of Internship In BTCL	<b>2</b>
<b>CHAPTER 2: ORGANIZATION</b>	<b>3-10</b>
2.1 About Telecommunication Company (BTCL)	<b>3</b>
2.2 Development Of BTCL	<b>3</b>
2.3 BTCL Services	<b>4</b>
2.3.1 Public Switch Telephone Network (PSTN)	<b>5</b>
2.3.2 PSTN Services	<b>5</b>
2.3.3 Asynchronous Digital Subscriber Line (ADSL)	<b>5</b>
2.3.4 ADSL Architecture	<b>6</b>
2.3.5 ADSL Limitation	<b>6</b>
2.3.6 Gigabyte Passive Optical Network (GPON)	<b>7</b>
2.3.7 Importance of GPON	<b>8</b>
2.3.8 Types of GPON	<b>8</b>

2.3.9 TNDP	8
2.3.10 MOTN (Modernization of Telecommunication Network)	8
2.3.11 Leased Line Internet (LLI)	9
2.3.12 Virtual Private Network (VPN)	9
2.3.13 NIX	10
2.3.14 Co-Location Service	10
2.3.14 Domain and Hosting	10
2.3.15 IIG and IGW	10
2.4 SWOT Analysis	10
<b>CHAPTER 3: TELECOMMUNICATION NETWORKS</b>	<b>12-22</b>
3.1 Telecommunication Media	12
3.2 Telecommunication Switching	12
3.3 Switching System	12
3.3.2 The Control Sub-System	13
3.3.1 Trunks Interface	14
3.3.2 Service Line Scanning Unit	14
3.3.3 Operator Console	14
3.3.4 Circuit Service Interface	14
3.3.5 Junctures	14
3.3.6 Subscriber Line Interface	14
3.3.6 Signaling	15
3.4 Switching System Classification	15
3.4.1 Manual and Automatic Switching	15
3.4.1 Electro Mechanical	16
3.4.2 Electro Stored Program Control	16
3.5 Network of Subscriber Line Telecommunication	16
3.6 Next Generation Network (NGN)	17
3.6.1 Principle of NGN	18
3.6.2 Functional Layers of NGN	18
3.6.3 Access Network Layers	19

3.6.4 Transport Layer	20
3.6.5 The Control Layer	20
3.6.6. The Service and application Layer	20
3.6.7 NGN Softswitch base architecture	21
3.6.7.1 The Media Gateway Controller	22
3.6.7.2 Application Server	22
3.6.7.3 Media Gateway	22
3.6.7.4 Access gateway	22
3.6.7.5 Trunking Gateway	22
<b>CHAPTER 4: TASK, PROJECT AND ACTIVITY</b>	<b>23-26</b>
4.1 The Daily Task in Switch Room and MDF Room	23
4.2 Task of Spicing	24
4.3 Some Safety Rules	24
4.4 Spicing	24
4.5 Task in IMS Softswitch	25
4.6 Challenges	26
<b>CHAPTER 5: IMS SOFTSWITCH</b>	<b>27-29</b>
5.1 IP Multimedia Subsystem	27
5.2 IMS architecture	27
5.2.1 Call Session Control Function	28
5.2.2 Home Subscriber Server (HSS)	28
5.2.4 Access Gateway Control Function (AGCF)	28
5.2.5 Access Gateway (AGW)	28
5.2.6 Inter AGW Basic Call Flow	29
<b>CHAPTER 6: POWER SUPPLY SYSTEM</b>	<b>30-31</b>
6.1 Power Supply System	30
6.1.1 Commercial Power	30
6.1.2 Substation	30
6.1.3 Regulator	30
6.1.4 Generator	31



6.1.5 Rectifier Room	31
6.1.6 Inverter	31
<b>CHAPTER 7 CONCLUSION AND FUTURE CAREER</b>	<b>32-33</b>
7.1 Conclusions of the Discussion	32
7.2 Possibility for a future career	33
<b>APPENDIX</b>	<b>34</b>
<b>REFERENCE</b>	<b>35</b>
<b>PLAGIARISM REPORT</b>	<b>36</b>

## **LIST OF FIGURES**

<b>Figures</b>	<b>Page No</b>
2.1: BTCL logo	<b>3</b>
2.2: BTCL Service	<b>4</b>
2.3: ADSL Architecture	<b>6</b>
2.4: GPONE working diagram	<b>7</b>
2.5: Modernization of Telecommunication Network	<b>9</b>
3.3.A: Switching Trunk flow	<b>12</b>
3.3.B: Switching Network System (TSSN)	<b>13</b>
3.4.A: Classification of Switching	<b>15</b>
3.5.A: Network of Subscriber Line Telecommunication (TSSN)	<b>17</b>
3.6.A: Functional Layers of NGN (TSSN)	<b>18</b>
3.6.5.A: NGN architecture (TSSN)	<b>19</b>
5.6.5.B: Application Server	<b>20</b>
3.6.5.B: Softswitch base NGN	<b>21</b>
4.1.1: working in switch room	<b>23</b>
4.2.1: Working for spicing	<b>24</b>
4.5.1: IMS softswitch security log	<b>25</b>
4.5.2: IMS softswitch manual backup data	<b>26</b>
4.5.1: Main Distribution Frame	<b>26</b>
5.1: IMS architecture (ZTE)	<b>27</b>
5.2: AGW Call Flow	<b>29</b>
6.1: Power Supply System	<b>30</b>

# CHAPTER 1

## INTRODUCTION

### 1.1 Introduction

Telecommunication networks is work as transmission media by passing the electromagnetic signal or optical signal through the fiber optic or copper cable which is used by people to transfer their data or information. Telecommunication is for transfer the data or information through the internet to one place to another in time. The data or information can be voice, image, text, video etc. To pass the information from one place to another we need a strong comprehend media. That reason we have to build up telecommunication networks that can used to transfer users information through that gateway. Bangladesh Telecommunication Company Limited (BTCL) operate that service in Bangladesh. It is the Government owned massive telecommunication company in the country. It has many minor and principal branch throughout the country. BTCL mainly operate land-line telephone and internet in metropolitan area in the country. I choose the BTCL for my internship the main reason I have an interest in telecommunication network and how they work it fascinate me to work in this field. For me BTCL is the best cause it has the vast are and many section to work with.

### 1.2 Motivation

Telecommunication played vital role in today's world, without it we cannot transfer our data to one to another place. So, telecommunication always attracted me to work in this field. So that I can be part of this field and deliver better services for the country. Still there is many parts in this field need to upgrade but without the proper knowledge it suffers. BTCL is the massive government own telecommunication company to work in this company would give me much better experience.

### 1.3 Objective

- ❖ I will get vast knowledge about networking and telecommunication.
- ❖ I can learn how the security important in this field and how the security work in this field.

- ❖ I will know what type of service can be operate in Telecommunication organizations.
- ❖ I learn about how the ADSL and GPONE works in telecommunication.
- ❖ I will know about how Softswitch works for transmission.
- ❖ I will know how Phones work in telecommunication.

#### **1.4 About the Company**

- In 1979 reinstalled as Bangladesh Telegraph and Telephone Board (BTTB)
- Digital telex exchanged started in Bangladesh in 1981.
- The BTCL is own by the Government of Bangladesh and select the directors.
- BTCL deliver both the internet and telephone service to the people of Bangladesh.
- BTCL also manage the long-distance call by the user.
- BTCL has NGN service which is for multiple broadband and telecommunication services.

#### **1.5 Outcome of Internship In BTCL**

- It will give me practical work experience in the telecommunication fields.
- I will know the required equipment which used for transmitted data.
- This internship will allow me to get real world experience.
- I can from the mistake that can happen in real world field.
- It will make me more professional than the traditional education.
- It will give me a positive vibe how to work with co worker and how to bond with them.
- I will get the experience how to control the situation under the pressure.

## CHAPTER 2

### ORGANIZATION

#### 2.1 About Telecommunication Company (BTCL)

Bangladesh Telecommunication Company Limited (BTCL) is a well-known telecommunication service provider in Bangladesh and contribute to the internet of 64 districts in the country. Previously it was founded as Bangladesh Telephone and Telegraph Board (BTTB) after the liberation war in 1971. Bangladesh Telecommunication Company Limited (BTCL) played vital role in telecommunication history in Bangladesh. Although it provides telephone service which is land-line but also it delivers wireless connection to internet. For the telephone and internet service which can be deliver by fiber optic cable or it can be copper cable. BTCL has 24-hour active customer call center. Customer who lived in Dhaka can get call service in any time. BTCL also operate red telephone service for VIP which is secured.



Figure 2.1: BTCL logo

#### 2.2 Development Of BTCL

Bangladesh Telecommunication Company Limited is recognize as BTCL.

- ◆ At first it founded in 1853 as The Telegraph branch in British India.
- ◆ Then after the independence it is remodel under Ministry of Post and Telecommunication in as Bangladesh Telegraph and Telephone Department.
- ◆ In 1979 it changes to Bangladesh Telegraph and Telephone Board (BTTB).
- ◆ Next Generation Network (NGN) was established in 2006.

- ◆ In 2008 BTTB which is known as Bangladesh Telegraph and Telephone Board reconstructed as Bangladesh Telecommunications Company Limited (BTCL). It was then owned by the Government to by buy 100 shares and selected 9 directors who are boarded by the secretary of Ministry of Post and Telecommunication.
- ◆ BTCL estimated net worth \$1.5 billion and BTCL has estimated almost over 13000 official staff.
- ◆ From Now BTCL is Public Limited Company which owned by Government of Bangladesh.
- ◆ BTCL operates internet and also the land line telephone service.

### 2.3 BTCL Services

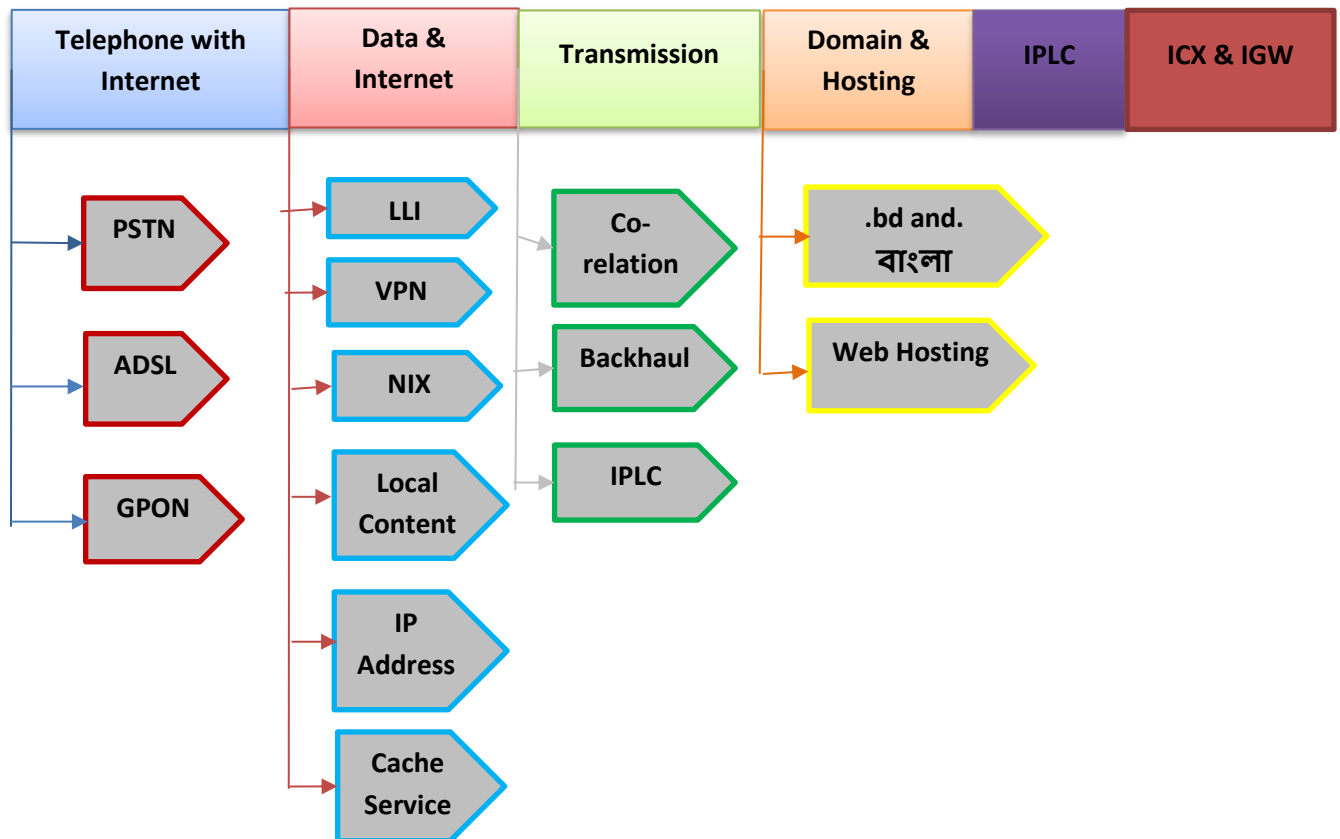

Figure 2.2: BTCL Service

There are various services operated by BTCL.

- ◆ Telephone and Internet for home and office
- ◆ Data and Internet secured line for user
- ◆ Transmission for operator
- ◆ Domain and Hosting
- ◆ IPLC (International Private Leased Circuit)
- ◆ ICX (Inter Connection Exchange) and IGW (International Gateway)
- ◆ IPTSP (Internet Protocol Telephone Service Provider)

### **2.3.1 Public Switch Telephone Network (PSTN)**

BTCL is distributor of PSTN operator in all over the Bangladesh. The main motive of the PSTN services is to strengthen the voice and data communication operation so that people can communicate with crystal clear voice. It is a fixed line circuit switch analog telephone network. Another purpose of this services is to send fixed phone services to gateway for the common people. It uses the under-ground copper connection to operate call.

### **2.3.2 PSTN Services**

- Local Exchanges: The PSTN service establish a session to start call between two points of BTCL nos. within the district.
- NWD: Which is inter connected district call between two BTCL nos.
- ISD: International Subscriber Dialing where it allows call over the line.
- VAS: BTCL operates value added services like call barring which can delay the call and also it provides call waiting in the queue.

### **2.3.3 Asynchronous Digital Subscriber Line (ADSL)**

ADSL is a copper-based telephone line for the short distance of the network. which is a data transmission technology used for faster data flow through the copper-based telephone line. It can flow the data 5 Mbps to 50 Mbps through the copper line. It is faster copper line to transfer the data. It has 1 way copper connection to transfer the data and voice over call. ADSL is a telephone exchange which can operate telephone calls and internet using a splitter on the DP. In ADSL for the subscriber can get way more faster data transfer rate in downstream than the upstream in this copper line. ADSL is a digital subscriber line which transmit digital data through over the line. ADSL has much better speed compare to ISDN

which is International Subscriber Dialing Network used for voice over call. In ADSL data transfer rate depends on the distance of the network. The main reason for it is the copper line have limitation to the long distance.

### 2.3.4 ADSL Architecture

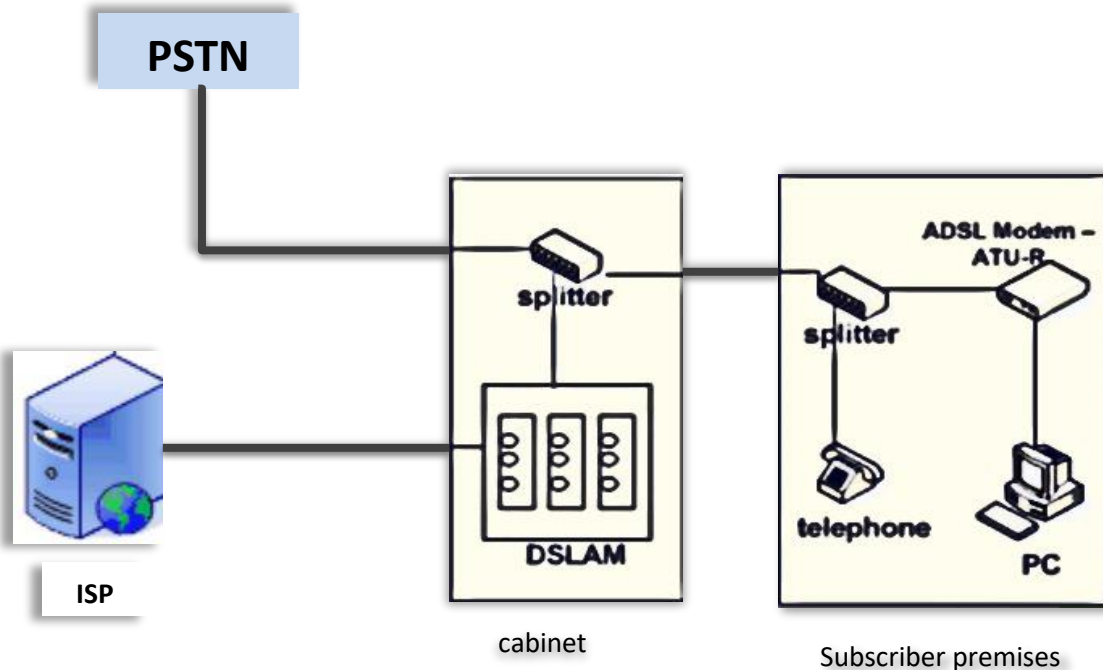

Figure 2.3: ADSL Architecture

ADSL is a copper-based line and it works only in existing PSTN. The internet come from the internet service provider then it goes to the cabinet where is a cabinet for existing for telephone network which is PSTN. In PSTN there is only one way to transmit the voice over data but in ADSL where it also provides the internet through the line. To operate both the telephone line and internet it uses the splitter to separated them. Then after it can transmit the data in separate way.

### 2.3.5 ADSL Limitation

- In ADSL distance matter if it is far from the local exchange.
- For long distance electrical pulse get attenuation through the copper line.
- The wire uses in ADSL copper line is more thicker so data get distracted when it flows through it.
- The wire has more joint so that data get resistance when it follows through it.



- For long distance in this line get lower speed for transmission the reason for that if the signal travel too long it become weaker.
- It will face difficulty when it installs as exchange point.
- ADSL works only in existing PSTN network.
- It is necessary to have telephone line which have to be good.

Although the ADSL network is more cost effective for the short distance than the other network to transfer the data uninterrupted to the users.

### 2.3.6 Gigabyte Passive Optical Network (GPON)

GPONE is very faster speed compare to ADSL network. GPON using fiber optic cable as transmission media to transfer the data. It is very faster using fiber optic cable. GPON transmittable data capacity is at least 1 Giga byte per second. GPON network has Optical Line Terminal (OLT) Optical Network Unit (ONU) and a splitter. The splitter is use for separate the signal when it transmits data through optical fiber. The OLT is work for converting the optical signal to electrical signal that coming from ONU. The OLT is connected to the operator which using glass optical fiber cable to transmit the data. The PON using wavelength division multiplexing to deliver bi directional communication through the optical fiber.

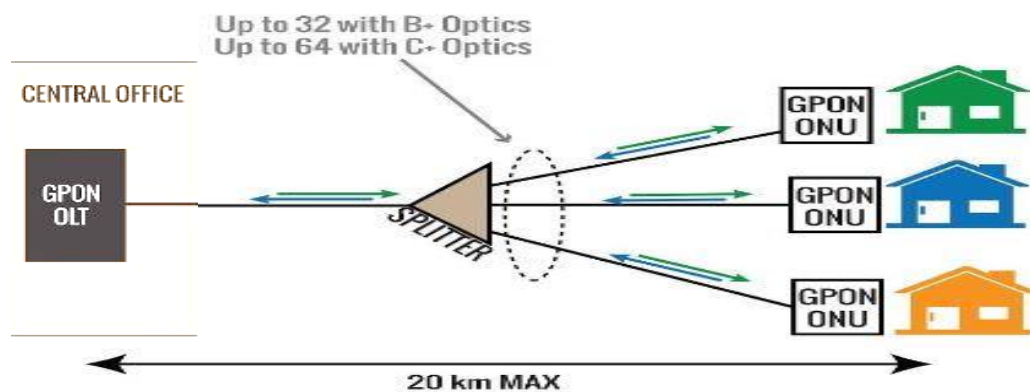

Figure 2.4: GPONE working diagram

GPON is very good at transmitting data in long distance. In GNON for long distance data can transmit without added attenuation. It is using the optical fiber to transmit the light signal so that it transmits faster and more accurate. In GPON network OLT played the main

role in it. When the data transmit from the operator it goes to the GPON Optical Line Terminal which is a device where it converting the electrical signal then it goes to the splitter which is device between the OLT and ONU. The OLT using the multiplexing to do the conversion. Then it followed to the ONU. The OLT is taking the optical signal that coming from ONU as light beam then the OLT converted it to a form of electrical signal. ONU is connected to the home or office where the user transmit data then the signal will come back to OLT.

GPON mainly use for long distance which can be up to 20km maximum.

### **2.3.7 Importance of GPON**

- It has extremely high bandwidth which is limited to other cable to work as transmission media.
- It is easy to upgrade so that newer version of equipment can be install easily to the OF cable that maximize the capacity of bandwidth.
- Fiber optic cable is attenuation free when it transmits the data.
- Easy to find the cable damage so that it will be fixed quickly and run the network.
- It is more secured than the other cable networks.

### **2.3.8 Types of GPON**

GPON (Gigabyte Passive Optical Network) is two types.

1. TNDP (Transmission Network Development Project)
2. MOTN (Modernization of Telecommunication Network)

### **2.3.9 TNDP**

TNDP is a hardware base telecommunication network which using router configuration to transmit the data. TNDP is using for better transmission of data in the network.

### **2.3.10 MOTN (Modernization of Telecommunication Network)**

MOTN is software-based telecommunication network which is using in BTCL. It is an optical fiber network to transmit the information through channel. MOTN has BOSS portal which is Business Operation Support System. Where all the connection gets a permission to transfer the data. The BOSS has CRM portal where the get resource to the customer. It also has OSS portal that is for operation support system.

OSS have a OFM section where it gets the complaint from customer and take action on it.

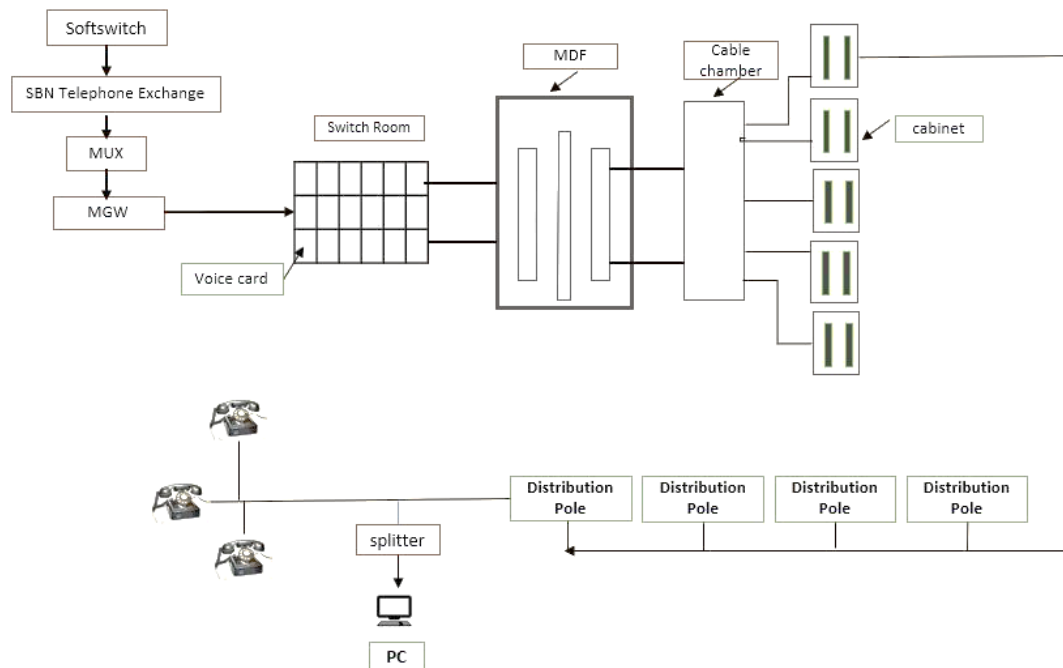

Figure 2.5: Modernization of Telecommunication Network

### 2.3.11 Leased Line Internet (LLI)

BTCL has the largest infrastructure for providing the leased line internet which is premium internet connectivity. The LLI is offered over the optical fiber. It has high-capacity router and also switches to all over the country. The leased line internet has 24/7 NOC services and it connected with the global upstream using some of the protocol. It consists by paying fees to get the leased internet network.

### 2.3.12 Virtual Private Network (VPN)

The VPN or the virtual private network allows the customer to make a secured private network communication over the public network. BTCL deliver the high-speed internet data service to the rural area. This service is for the organization who need to secured connection to shared information.

### 2.3.13 NIX

NIX is a National Internet Exchange where it delivers the internet connection throughout the inside Bangladesh. Nix has two exchange point to provide the internet.

### **2.3.14 Co-Location Service**

In BTCL where some other operator who is using internet service can lease with fees some racks at BTCL so that when it necessary the operator can keep and operate their materials.

### **2.3.14 Domain and Hosting**

BTCL provide the top-level domain in the internet world. The domain is using for authentication for the unique identity and .bd is one of the known domains in Bangladesh. It is the address of Bangladesh to identify in the internet world. The hosting is using for host the web pages using the server which provided by BTCL to the organization who need it.

### **2.3.15 IIG and IGW**

IIG is International Internet Gateway which works for as a gateway of the internet. BTCL provide ISP license service to the mobile operator. So that mobile operator will get the internet transmission facility to transmit in to the world.

IGW is using for international voice over call through BTCL IGW nodes.

## **2.4 SWOT analysis**

I am finding some strengths of the company they also have some weakness, threats and also have good opportunity to work with what I see when I work in BTCL.

### **Organization Strengths:**

- Bangladesh's largest communications company
- It offers a range of services, including internet and phone lines for homes, businesses, government agencies, and private offices.
- This is a government-owned telecommunications company that consistently receives assistance from the government of Bangladesh.
- It has numerous locations across the nation.
- Maintaining a large amount of personnel and equipment.
- Employees are dedicated to the company and have high levels of skill.

**Weakness:**

- There are not enough employees.
- The wage structure is inadequate, and the workforce lacks motivation.
- Marketing policy is very bad.
- Inadequate training for the workforce
- Less security for the cable sometimes stolen.

**Windows of opportunity:**

- Increase the workflow's rate of automation.
- Optical cable for the internet and telephone services.
- The internet speed is pretty fast.

**Vulnerabilities:**

- Hacker's strike in the site.
- Sometimes, customers are not reliable.
- Thief stole the cable

## CHAPTER 3

### TELECOMMUNICATION NETWORKS

#### 3.1 Telecommunication Media

A communication media that can transfer and receive information or it can be data which using the wire or optical cable to transmit the electrical signal from one place to another is communication media. The telecommunication media can be different to transfer the data through the channel. The main purpose of telecommunication is to electrical signal transmitting in form of information. The information or the data can be telephone calls, audio-video, text or image etc. Ring down circuit can be used in this telecommunication switching. A ringdown circuit is used to dial a specific number from a telephone immediately after using the handset or pressing a key. Determined by the end-user device type electrical signal distinguish between subscribers and switch. The wide mutation of signal has different characteristics that led to alternative service of specific telecom network.

#### 3.2 Telecommunication Switching

Networks of specific telecommunication service,

- It can be Telegraph Network
- Telex network
- Data or Telephone network

#### 3.3 Switching System



Figure 3.3.A: Switching Trunk flow

The hardware used to connect inputs and outputs is called a switching matrix or switching network. This switching network is a set of connections formed when connecting inputs

and outputs. Therefore, it differs from the communication network described above. Switching system can be used to established a call connection.

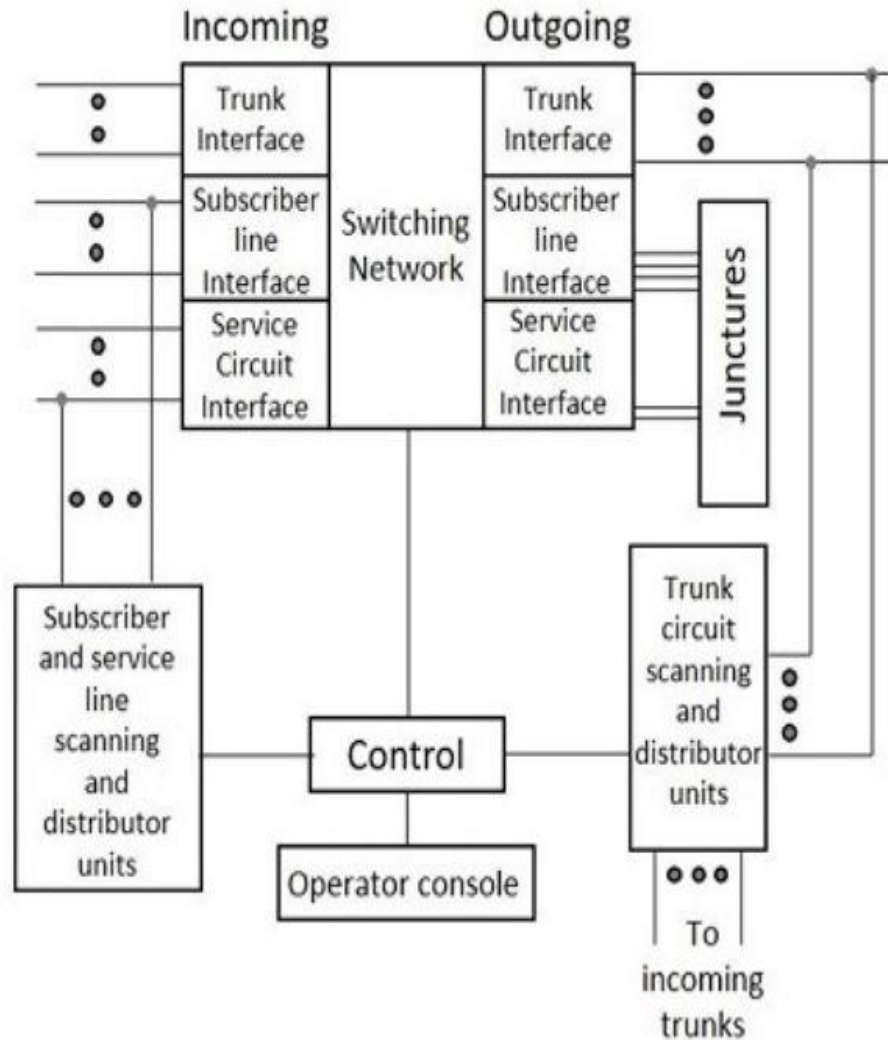

Figure 3.3.B: Switching Network System (TSSN)

### 3.3.2 The Control Sub-System

This is an very important part of any active switching system. It would identify the inputs and it establish switching paths then interpreting output lines and received signaling information with these lines. The control sub-system played important role to control the signal by making it and it can break the connection if needed by interpreted the signal that

transfer on the lines. The control sub system sends the signal of a data to subscriber who is the receiver and the information will exchange through the outgoing trunks.

### **3.3.1 Trunks Interface**

A trunk is a single communication path that enables several subscriber lines at one end to connect with the appropriate subscriber line at the other end to transmit information. It is a connection that sends multiple signals at once to make the network access between the two nodes more effectively. The trunk interface used to buildup connection between the switching networks and it accomplish in this port. In the trunk interface working as a point where all the trunk line meets to the switching system.

### **3.3.2 Service Line Scanning Unit**

In the service line scanning unit, it knows the signal and gain the signal of the information from the incoming trunk. Then the data that gain from the system goes to the control sub-system to identify and also check whether it is authentic to deliver incoming and outcoming service.

The distributor units is working as for the distributing the signal or sending the signal of information through the trunk circuit units when it done at the distribution scanning unit.

### **3.3.3 Operator Console**

The operator console allowed the interconnection with the switching network system for some of the purpose which can be for maintenance or it can be for administrative purpose.

### **3.3.4 Circuit Service Interface**

The service circuit is interface where it delivers the interconnection with the circuits for purpose of testing it and maintaining the interconnection.

### **3.3.5 Junctures**

The junctions that take action to connect subscribers and service circuits are referred to as junctures. When using the local network for both calling and receiving subscriber lines, junctures will connect for local calls, negating the requirement for a trunk line.

### **3.3.6 Subscriber Line Interface**



The subscriber is a connection-building tool for subscribers. On this port, the switching system also comes to an end. and the point where the lines from the subscriber are joined is the subscriber line interface. The switching system is connected to the participants.

### 3.3.6 Signaling

Signaling is the use of signals to monitoring the communication. Control the line instead of manually configuring the line by the user administrator.

### 3.4 Switching System Classification

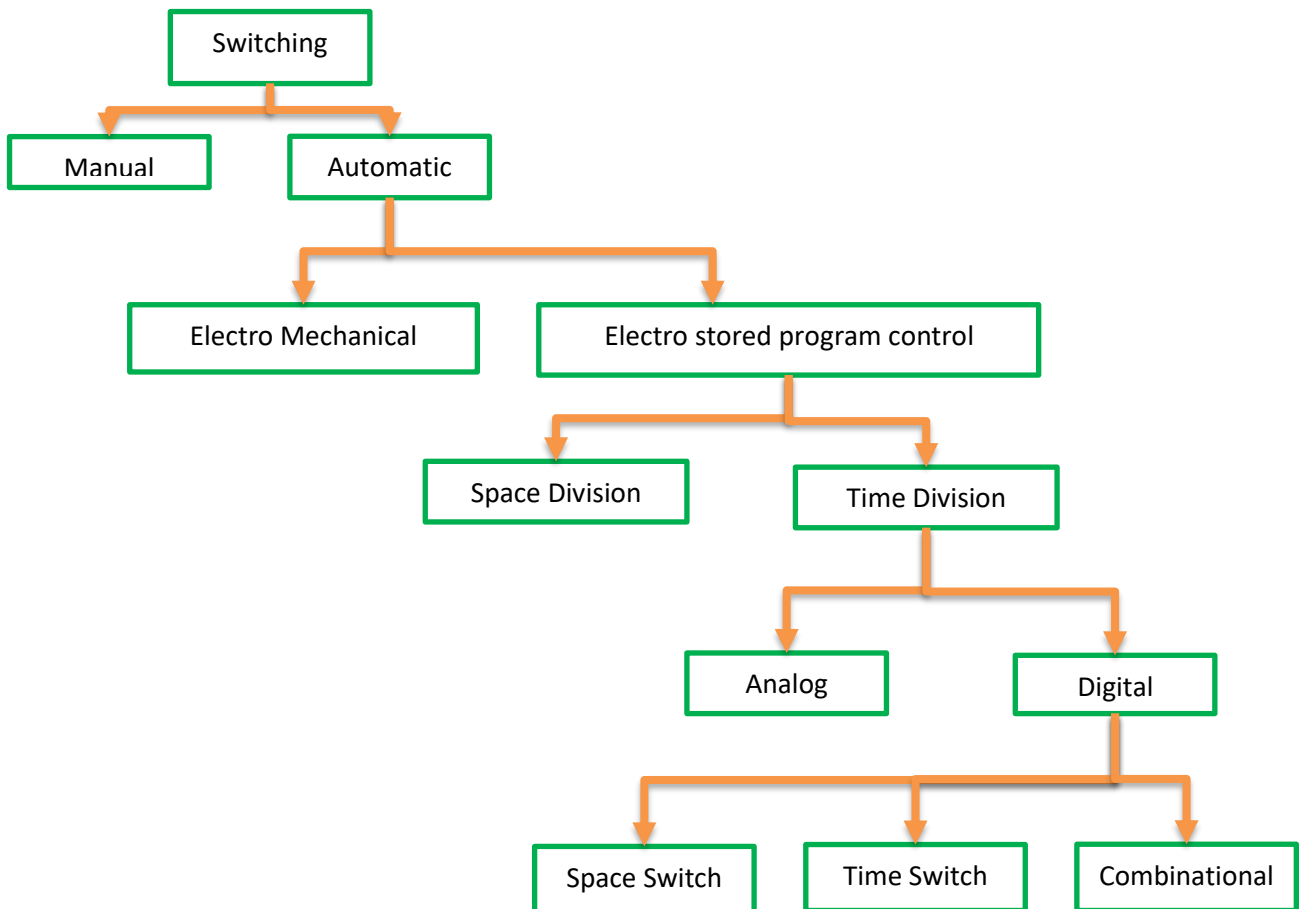

Figure 3.4.A: Classification of Switching

#### 3.4.1 Manual and Automatic Switching

It uses in the early state when the switching system creating to established the pathway to the subscriber lines. This type of switching system operated manually and it is used in

telephone exchange to operate a connection between the subscribers. It is hard to monitor and operate so to be for easy uses there is established automatic switching. Which is easy to operate than the manual switching.

### **3.4.1 Electro Mechanical**

It is established after the manual switching which is complex to maintain. Where it takes up large scale of space so there is an upgrade for that.

### **3.4.2 Electro Stored Program Control**

- It is used for the lowering the space so that the switch transfer connection would be more powerful and impact to the system to operate its operation. In electro stored program manage the control where there is use of IC, transistor or more device which make the switching more time ingesting to performed.
- The switching employed by the electronic switching systems is also Space Division switching system or Time Division Switching. In area division switching, a dedicated path is established between the career and also it referred to as subscribers for the whole period of the call. In time division switching, sampled values of speech signals are transferred at fastened intervals.
- In the time division it can be analog which is transfer voltage as they are not converted. But in the digital or the binary switching the voltage that go through analog signal will transform to binary code then the binary code will transmute through the switching. In the binary switching it depend on time interval for the input to the output form then it followed the space switching. But in the time switching the value is stored in the switching and then transfer in time.

## **3.5 Network of Subscriber Line Telecommunication**

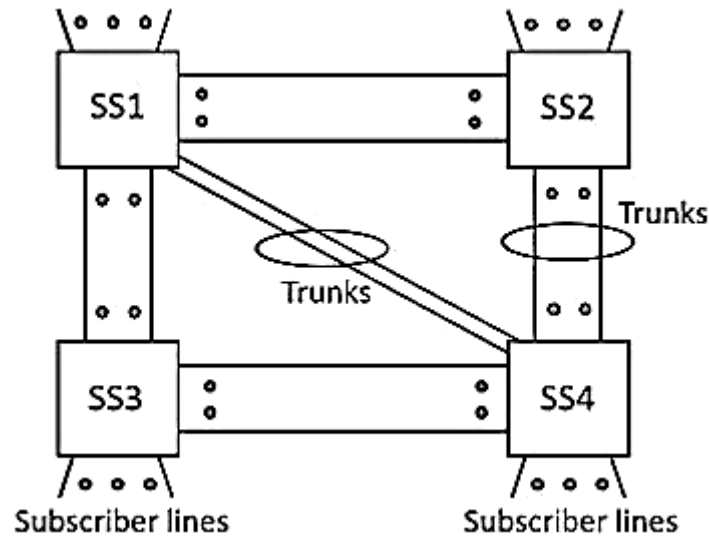

Figure 3.5.A: Network of Subscriber Line Telecommunication (TSSN)

A telecommunications network is a set of systems that creating a long-distance connection. Switchboards are part of a telecommunications switching network. The switching exchange deliver a connection between different types exchange of subscriber and that system have chance to be a set of groups. A subscriber will make a call so that the operator will create a session to connect it to the receiver line. It is a trunk call system when it creates a call for the subscriber line. The local or international call is get through the subscriber line and make outgoing or a incoming call for the subscriber.

### 3.6 Next Generation Network (NGN)

The Next Generation Network or NGN is transferring the network packet through the connection. NGN operates the telecommunication service which can be used for transferring voice over the network. It can use the some of the various broadband for the transmission that accommodate the Quality of Service (Qos). It using to get the many services in one network so that transmission is more fluent to the users and allowed the user to access the different service providers. It standardized the support to the user to get the better mobility of the services and also give access to congruent service to the users. The users will get more available service in Next Generation Network because it delivers the several many more service to users which is available in this network.

### 3.6.1 Principle of NGN

- All the existing network which transmitted the data or information are trafficking to NGN network.
- It is upgrading day by day in field to access more of the technology.
- NGN network is IP based networks transmits the packet through the connection.
- Supplying many services in one network and also developing the new services.
- It is using IP address to share the information through the connection.
- NGN using the access point convert and send the signal to the network.
- In NGN networks data perambulation around so it is always available.

### 3.6.2 Functional Layers of NGN

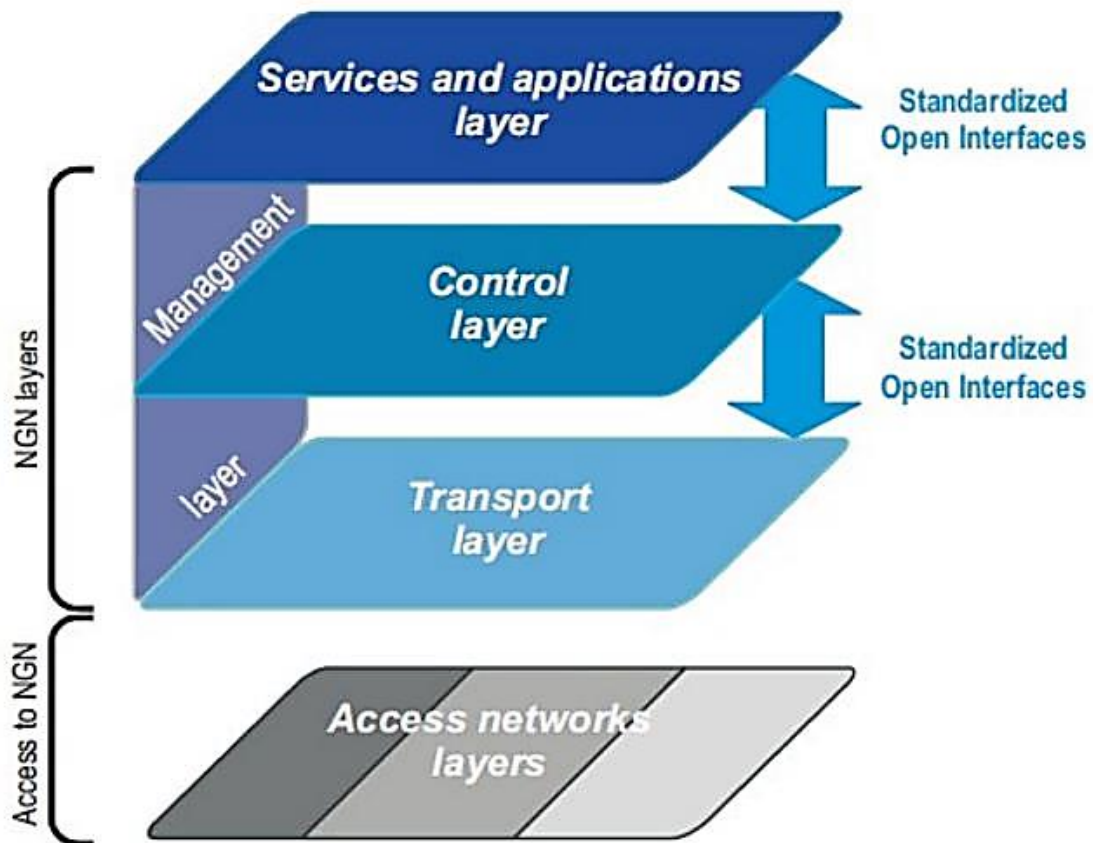

Figure 3.6.A: Functional Layers of NGN (TSSN)

### 3.6.3 Access Network Layers

In access layer it can transmit the data in both ways, it can be cable connection or it can be wireless connection which is fixed. The signal that is transmitting will be fixed and it goes to transport layer. In access layer data can transmitting wireless via satellite in this layer. When connection creating a wireless session, the user gets access from satellite which receive the signal from nearest point and then it sends to destination network to transmitting the information. Access layer give the user access to the various service of NGN.

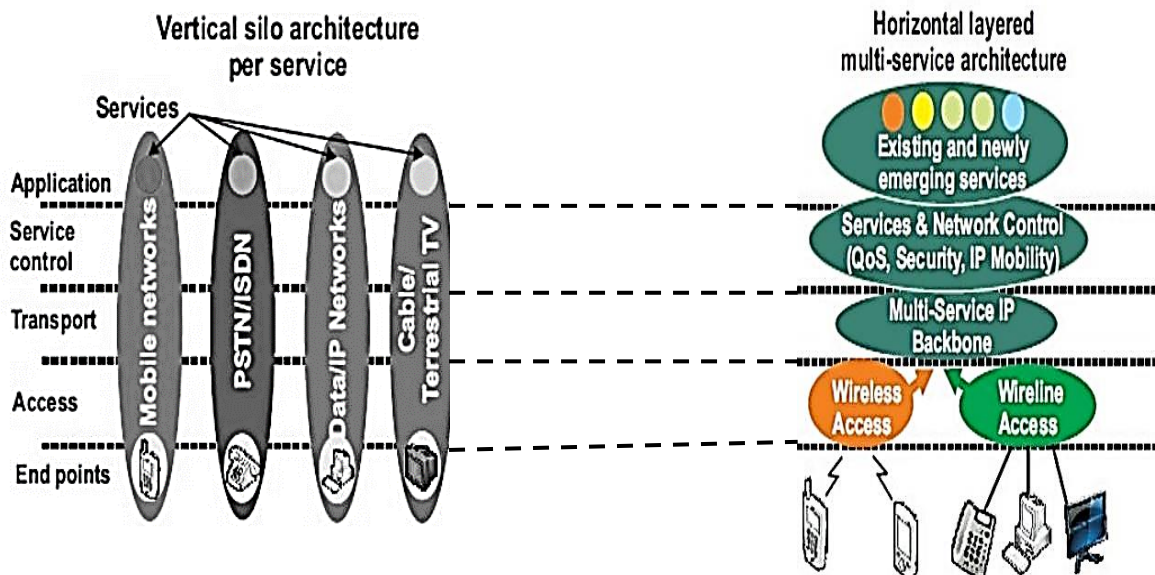

Figure 3.6.5.A: NGN architecture (TSSN)

### 3.6.4 Transport Layer

In transport layer is working as media gateway for the individual points of a network that is connected via access layer network. The information that transmits from one node to another they using transport layer to do that. The data which have to transmit convert to

signal to pass through the transport layer. The transport layer transfers the transmission network packet using media gateway.

### 3.6.5 The Control Layer

The control layer is controlling the services of NGN which can be establish a connection or canceling the connection. It works with the network elements of the NGN. The control layer is operated to manage the signaling and call flow. In a control layer it can set up a call through the media gateway and can cancelling the transmission of a call flow sessions. Although it has the control over the transmission which is isolated from the switching networks.

### 3.6.6. The Service and application Layer

The service layer is for the services that exhibit in the NGN networks. In this service layer NGN can deliver more service to the user. It is delivering the service which is required for the use that is from the control layer. It can start the service for the user and have control over it.

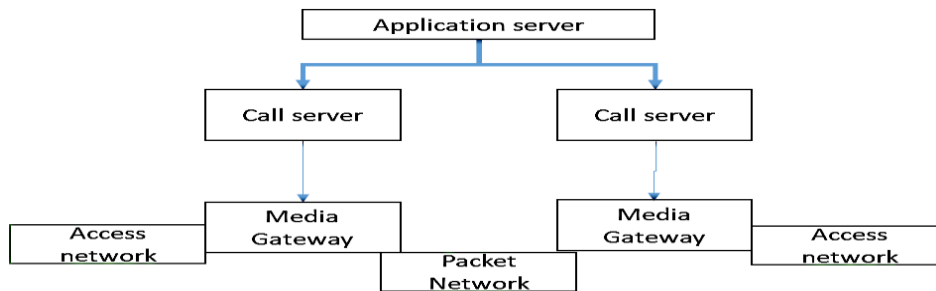

Figure 5.6.5.B: Application Server

### 3.6.7 NGN Softswitch base architecture

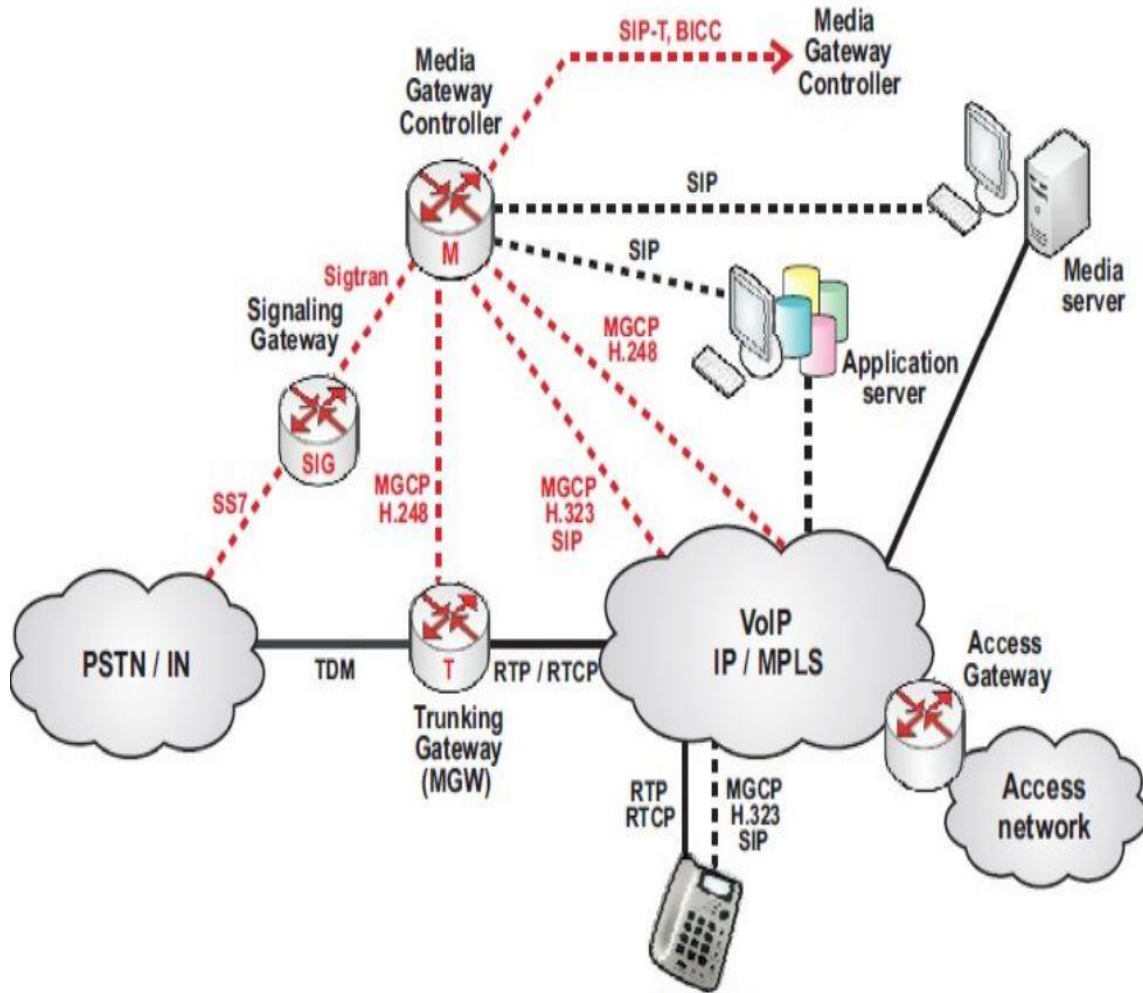

Figure 3.6.5.B: Softswitch base NGN

Softswitch in NGN networks established communication through the internet, it can use both the wireless cable networking or cable network to transmitted the voice over the NGN network. Softswitch usually a IP based technology to provide the voice data or information to the network.

### 3.6.7.1 The Media Gateway Controller

In softswitch NGN the media gateway controls the call flow in the NGN network. It operates the transmission service control in the NGN network. It manages call through the media gateway where it uses the H.248 protocol. It passes the signal between the signaling

gateway. Media gateway create new service to the user for operator so that can get revenue from it. It has the more facility when it creates the service and perform the operation.

- It is transmitting the unified messaging to the controller.
- It is easy and simple to integrate the other components of the network.
- It has the lower cost to provide more accurate solution to the operators.

### **3.6.7.2 Application Server**

In application server provides the call service to execute to end user. In NGN network of softswitch application server is to give control over the network.

### **3.6.7.3 Media Gateway**

It working as the transport gateway to transmit data through internet and operates all function of media gateway to transmit information to the different networks. When there is repetition of data it will cancel it although it will transport the information.

### **3.6.7.4 Access gateway**

The access gateway is using for accessing the network allow secure connection to pass the internet packet. The subscriber can access the NGN network through the access gateway.

### **3.6.7.5 Trunking Gateway**

It works as a media gateway for tdm connectivity which is using in telephone network to pass the voice to the destination.



## CHAPTER 4

### TASK, PROJECT AND ACTIVITY

#### 4.1 The Daily Task in Switch Room and MDF Room



Figure 4.1.1: working in switch room

In switch room in ODF a card has been failed so I make new connection to it.

## 4.2 Task of Spicing

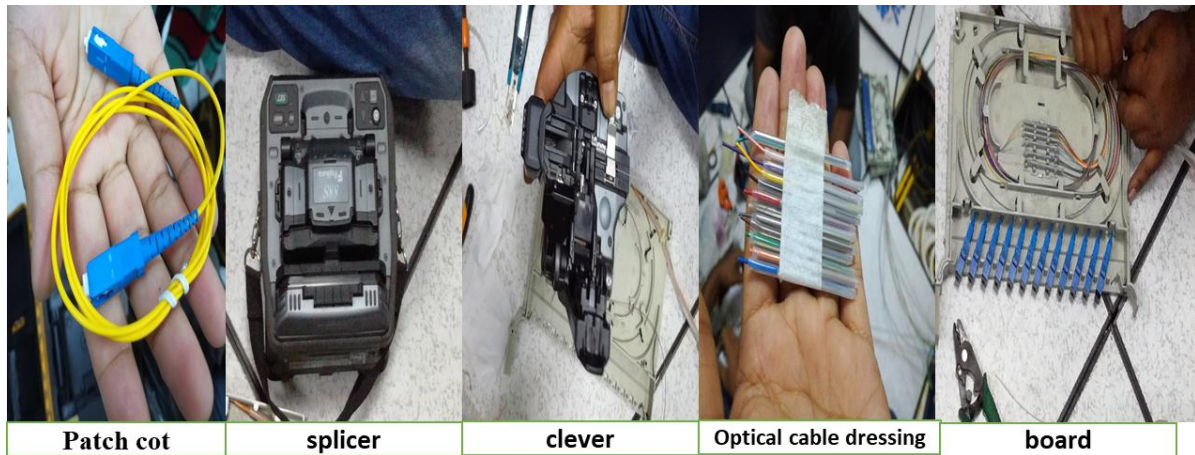

Figure 4.2.1: Working for spicing

## 4.3 Some Safety Rules

- Keep your workspace tidy.
- Think about your surroundings.
- Utilize tools for the purpose for which they were created.
- Eat nothing or consume anything while working.
- Report issues or injuries right away.
- learn how to contact the emergency services.

## 4.4 Spicing

Select the right splicing program or configuration for the optical fiber you will be splicing before turning on the fusion splicer. The protective heat-shrink tubing should be slid over one end of the optical fiber and moved up the cable far enough to be out of the way. Use a stripper to remove about 3 cm of buffer and/or coating from the optical fiber. Pull the optical fiber through a lint-free wipe that has been saturated with cleaning solution for optical fibers to clean it. Put the optical fiber in the cleaver and cut it to the required length.

The optical fiber must be cut. In the fusion splicer, insert the optical fiber as directed by the manufacturer. Place the optical fiber's end face between the electrodes. Put the electrode cover back on. start fusion-splicing of the process. Place the heat-shrink tubing from step 2 over the splice after taking care to remove it carefully. To seal and safeguard the splice, place the tubing and splice in the heat-shrink oven.

#### 4.5 Task in IMS Soft-switch

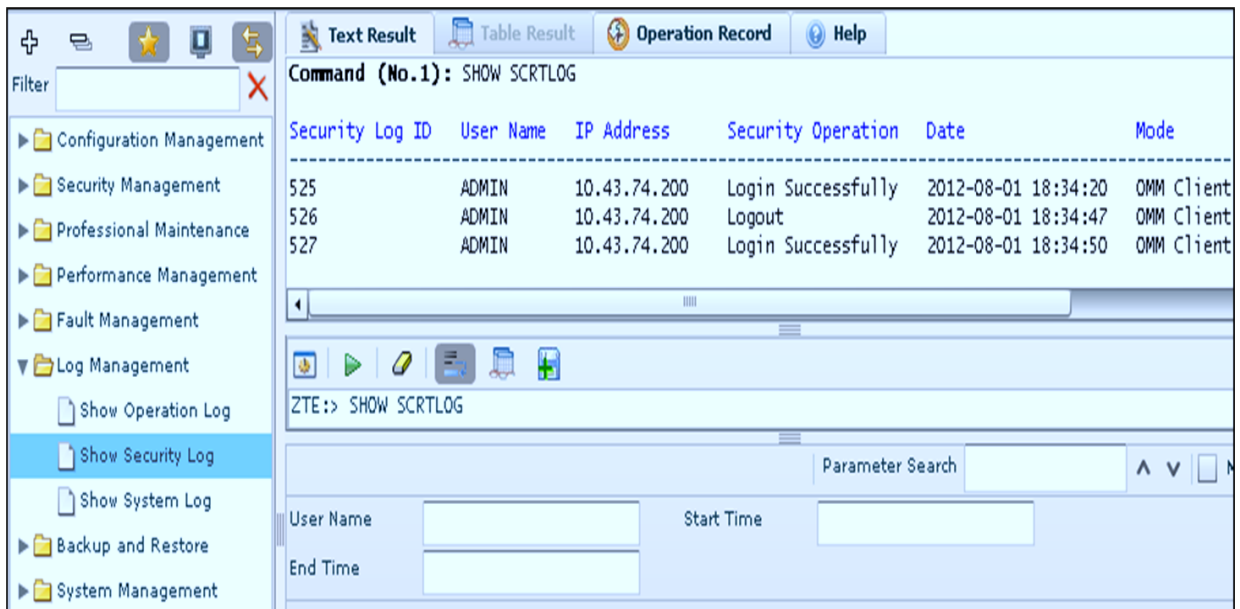

Figure 4.5.1: IMS softswitch security log

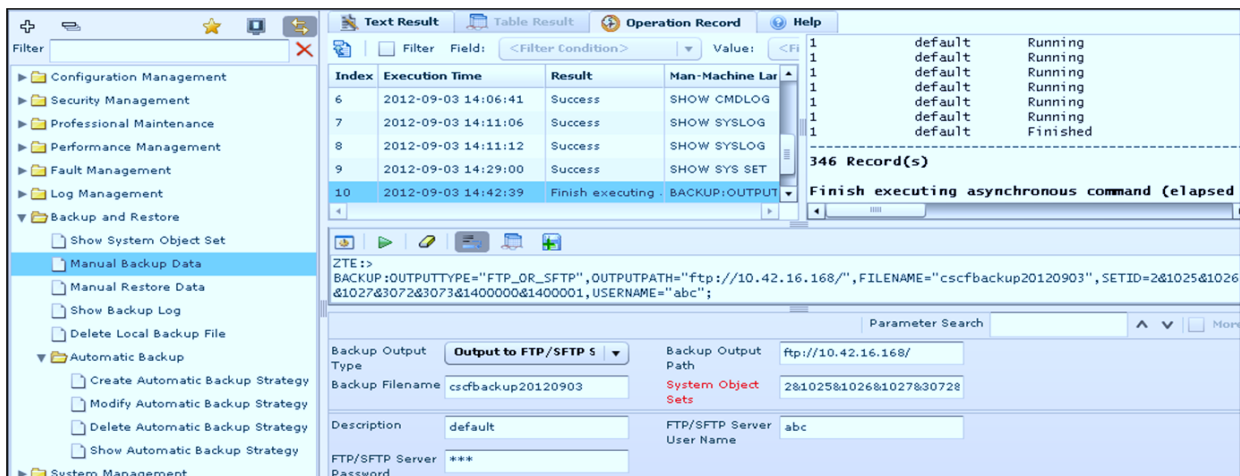

Figure 4.5.2: IMS softswitch manual backup data

## 4.6 Challenges

Telecommunication sector is massive in the range of equipment. There is so many I don't even know that they exist. I saw many of the equipment unknown to me. So, it is hard for me to learn new things in short term of period. I just tried my best to capture what saw in my eye. I had been worked on MDF where get knowledge about the transmission occurred in MDF. I tried to get to know the things as possible as I can so that I can develop my knowledge in future on this field.

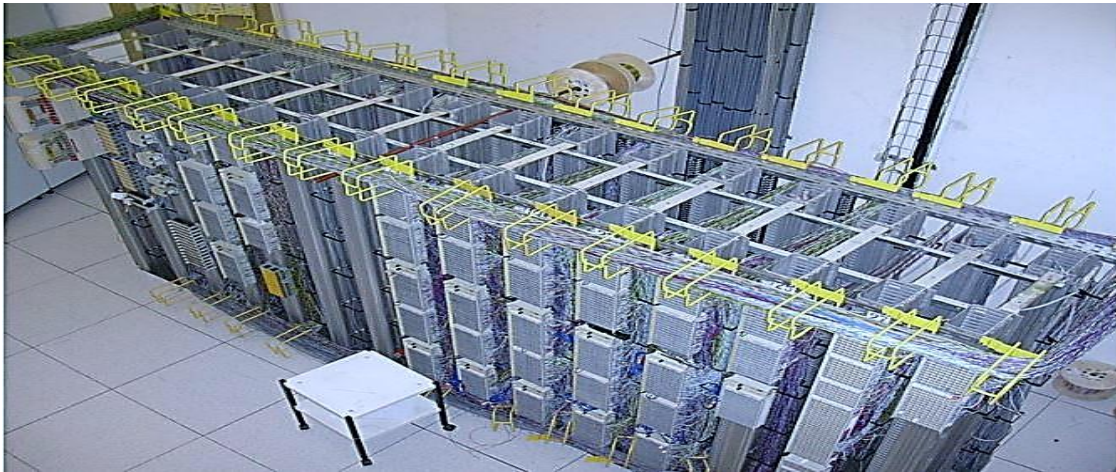

Figure 4.6.1: Main Distribution Frame

# CHAPTER 5

## IMS SOFTSWITCH

### 5.1 IP Multimedia Subsystem

IMS is a IP based framework that operate the multimedia services. It can used both wired and wireless network to transmitted the data through the internet. IMS has various of service to deliver to end user. IMS network allowed the user phone or computer connect to the IMS network to transfer the data. It using the IP transport service to the user and the services can be call, voice over media, video sharing.

### 5.2 IMS architecture

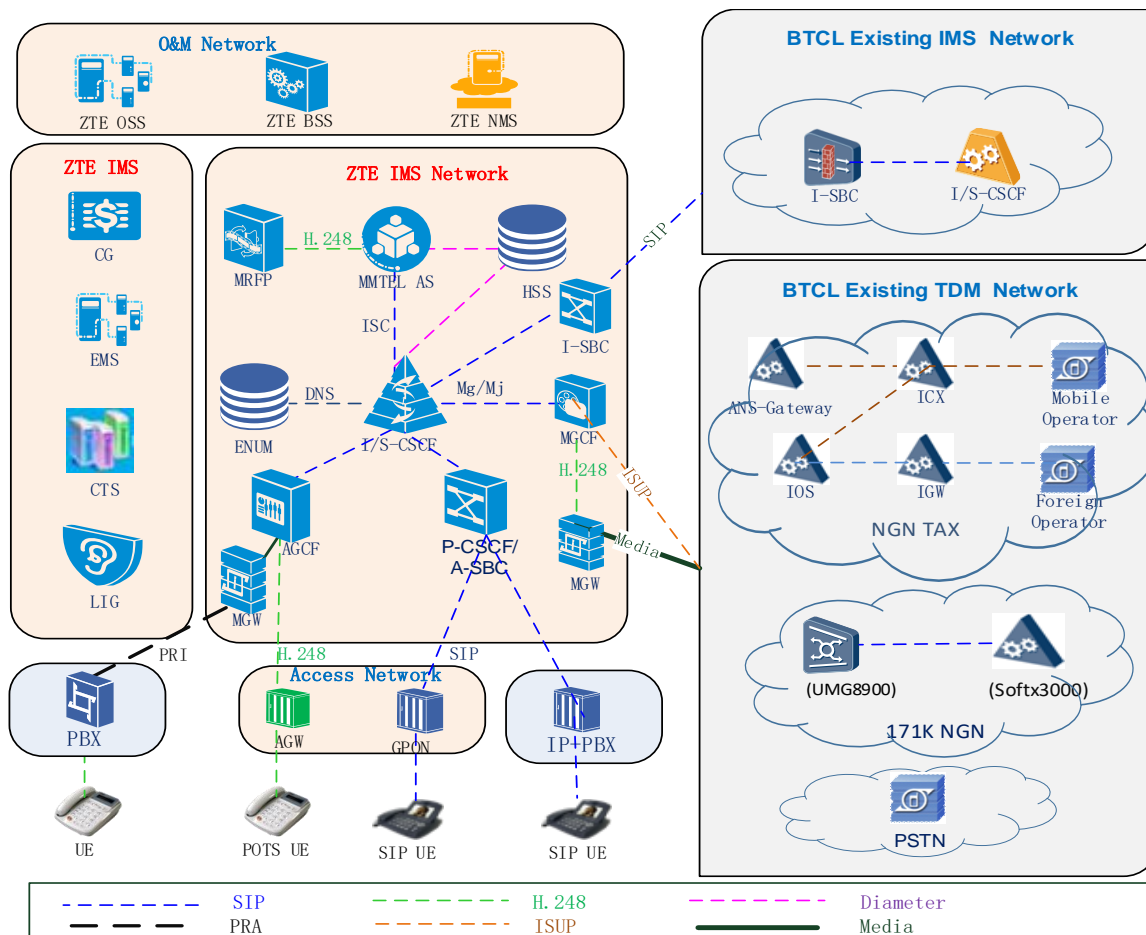

Figure 5.1: IMS architecture (ZTE)

### **5.2.1 Call Session Control Function**

It is the heart of the IMS which is used signal to establish a call session in IMS to transfer the data as signal packet to the IMS. It consists of the P-CSCF, I-CSCF, S-CSCF and BGCF for call control, service triggering, and routing. It is based on the ATCA hardware platform.

### **5.2.2 Home Subscriber Server (HSS)**

It is use to check the user profile in the server. HSS is operate the database entities which is uses to operate the use calls. It provides the subscriber identity where it evaluates the user authentication and authorization. It serves as an HSS that stores all subscriber-related data on the IMS, including user identity information, authentication data, service data, access parameters, service triggering information, and roaming information. The ZXUN USPP-IMS HSS is based on the ATCA hardware platform.

### **5.2.3 ENUM**

It is working as of managing the subscriber's data through the DNS server.

### **5.2.4 Access Gateway Control Function (AGCF)**

AGCF is that the initial association purpose between RG (residential gateway) and noble metal (Access entryway). AGCF works as MGC (Media Gateway Controller), like RG and AG. It provides PSTN (Public Switched phone Network)/ISDN (Integrated Services Digital Network) simulation for old simulated users/family users.

### **5.2.5 Access Gateway (AGW)**

- Subscriber initiates a decision to a different subscriber situated beneath same Co-located AGW.
- Signaling is forwarded to CSCF through AGCF
- Signaling is additional forwarded to I-CSCF that will interrogate with HSS and can forward the communication message to AGCF through CSCF

- AGCF will forward the signaling message to the call subscriber through Co-located AGW.
- After signaling flow completed media path are going to be established from Caller to call through the Co-located AGW.

### 5.2.6 Inter AGW Basic Call Flow

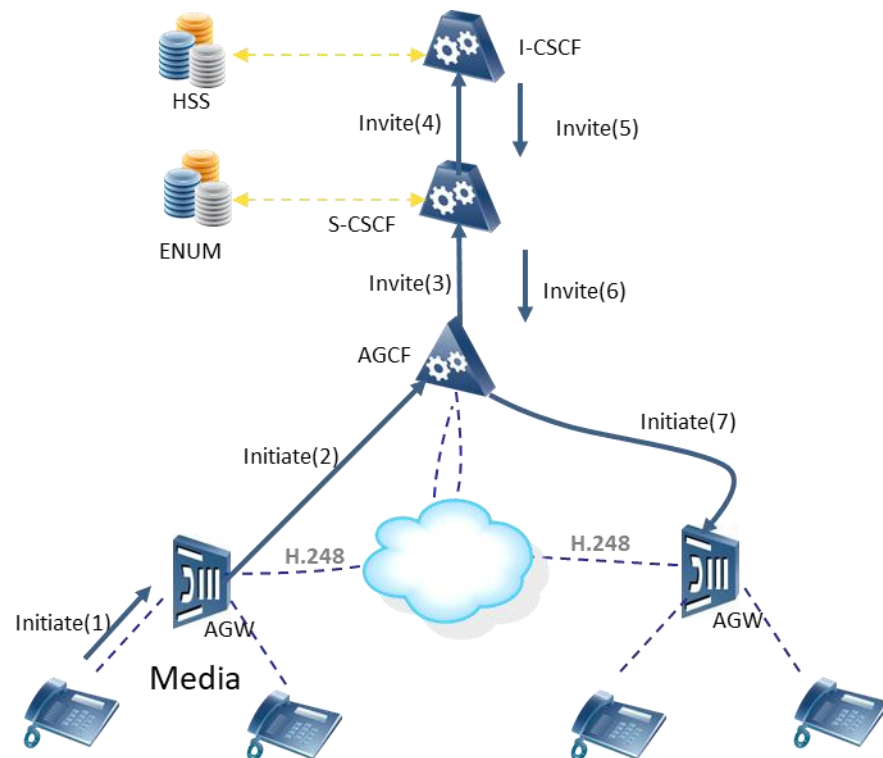

Figure 5.2: AGW Call Flow

The AGW of call in IMS is when there is call start from the telephone it goes to the access gateway using a media. Then it goes to Access Gateway Control Function where it will the use authenticity to transmit the call using IMS. After the verify of the user it goes to the CSCF where it will establish the call session for that network. Then after it transmit through AGCF to the same AGW of the IMS. Then the session starts requests to the receiver of call destination and then they can transmit the data as pass the signal through IMS.

## CHAPTER 6

### POWER SUPPLY SYSTEM

#### 6.1 Power Supply System

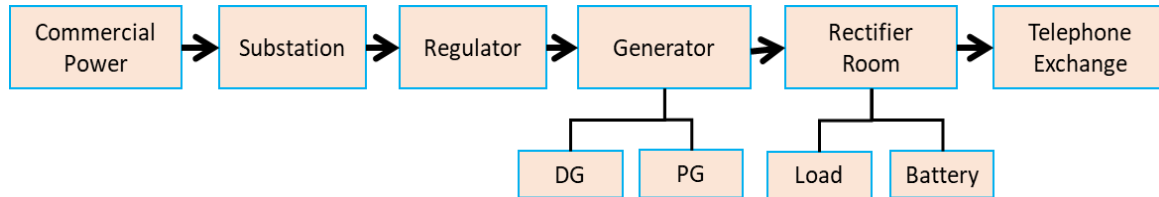

Figure 6.1: Power Supply System

#### 6.1.1 Commercial Power

Power system is vital part of an organization without it an organization can't continue its service. There is many of the power supply company but in BTCL commercial power supply coming from the DESCO. The DESCO provide the 11kv line of AC power supply to the BTCL. The voltage rating of the power supply is 200v to 400v and it has 50HZ amplitude.

#### 6.1.2 Substation

The substation has many parts like transformer, KV metering unit, ST panel. The commercial power supply which DESCO provided to BTCL is an alternating current or AC power supply which come to BTCL substation where there is a transformer. The transformer works is to when it receives bulk power it will convert it to usable amount of power which is 200v to max 400v voltage. If there is more than the voltage and the transformer does not work then the transmission line will short circuited or line will down by that. The BTCL substation using 3 phase transformers for the ac power supply.

#### 6.1.3 Regulator

In BTCL there is two types of equipment in the services. Regulator has a AVR and battery. The AVR is automatic voltage regulator and a battery which is for additional power supply if the power supply goes off.



1. Telecom Equipment
2. Environment Equipment

Telecom equipment is BTCL are like firewall, switch, router etc. many more equipment which need special voltage to run. So that using that regulator to gave the telecom equipment a required voltage to run.

And the environment equipment's are AC, light, Fan, camera, computer device, LED monitor which is also need specific voltage to run that reason regulator is using for that.

### **6.1.4 Generator**

There is two type of generator which are portable generator and diesel generator and the diesel generation is using by BTCL. The generator has a ATS service which is using for automatic transfer switch. When the commercial power supply go off the generator will automatically start to power supply and then again when the commercial power back on the generator will automatically goes off.

### **6.1.5 Rectifier Room**

The rectifier is using for convert the ac power supply to dc power supply. It has 2volt of 48volt 24x2 cell battery parallely connected to the rectifier. If there is sudden disruption of power supply the battery will provide power supply will last up to 3 minutes long.

### **6.1.6 Inverter**

The requisite DC to AC electrical converter modules for supply AC power to any instrumentation that needs it should be enclosed within the contract. an influence supply is provided by the backup battery. Electronic switch-mode inverters with automatic redundancy management functions are required.

## CHAPTER 7

### CONCLUSION AND FUTURE CAREER

#### 7.1 Conclusions of the Discussion

Implementing analysis and innovation on telecommunication operations, a dynamic and essential part of the telecom sector, may be a humongous, challenging, professional, and long task that needs sturdy observation skills, fast learning abilities and higher analytical capabilities, among different things. As a result, I'm happy and alleviated to possess completed and documented my position expertise during this well-known Telecommunications business in an exceedingly hospitable environment. By the grace of Allah, my honorable preceptor and educators from Daffodil International University and my expertise is due in part to the direction of the BTCL Mirpur and Sher-e-Bangla Nagar Exchange softswitch divisions. My beloved family and my lovable friends are encouraging me all the way of my journey and I give my all dedication to it and my hard work I'm thankful to them with my heartiest gratitude. I would admire it if this internship dissertation on the BTCL Telecommunications System were accepted in an exceedingly positive and hospitable manner.

Despite the fact that my internship delivers excellent learning skill and practical real-world experience. Although it was very pleasant for me to give much time on it .Another reason would be company's code of ethics which prohibited employee to give specific document of the company. They were hampered by the requirement to take care of company confidentiality and secrecy. It ought to be noted that operating for any telecommunication based mostly corporation desires staff to be not solely acquainted with with, however conjointly practiced with the technology utilized in the organization's on-line operations. Every member of the Telecom division staff receives in-depth training in order to achieve this requirement. They were kind enough to teach me the fundamentals of operating a telecom network. And even though I only had a limited supply of the knowledge about it .This considerably increased my understanding of networking activities and gave me more time to finish my internship.

## **7.2 Possibility for a future career**

As a student pursuing a highly regarded degree in Computer Science and Engineering, my internship at Bangladesh Telecommunications Company Limited has enabled me to engage in significant and beneficial practical activities while putting my theoretical skills to good use. By the immensely talented and well-respected faculty members of my favorite educational institute, Daffodil International University. Particularly my noble mentor has assisted me in overcoming any challenges I've had throughout my internship. As a result, I am appreciative of Bangladesh Telecommunications Company Limited (BTCL) for giving me a practical setting in which to perfect my telecommunication abilities as well as my esteemed lecturers for laying a strong educational foundation for me. As a result, I am pleased to regard this internship as a turning point in my development as a capable practitioner. The foundation of my effort was my degree from my favorite university.

## APPENDIX

### Company Details

**Name:** Bangladesh Telecommunication Company Limited (BTCL)

**Address:** Head office 37/E, Telejogajog Bhaban, Eskaton Garden Dhaka.

**Tel:** +880248311500

**Email:** [md@btcl.gov.bd](mailto:md@btcl.gov.bd)

**Call Center:** 16402

**Website:** <http://www.btcl.gov.bd/>

## REFERENCE

[1] Bangladesh Telecommunication Company Limited (BTCL), available at <<<http://www.btcl.gov.bd/>>> (last accessed on 03-12-2022 at 10:40PM).

[2] Bangladesh Telecommunication Company Limited, available at << <http://www.wikipedia.org/>>>, last accessed on 27-11-2022 at 10:20 AM

# INTERNSHIP IN NETWORK ENGINEERING OF SOFTSWITCH AND PHONES AT BTCL

## ORIGINALITY REPORT

<b>10%</b>	<b>9%</b>	<b>0%</b>	<b>5%</b>
SIMILARITY INDEX	INTERNET SOURCES	PUBLICATIONS	STUDENT PAPERS

## PRIMARY SOURCES

<b>1</b>	Submitted to Daffodil International University Student Paper	<b>3%</b>
<b>2</b>	dspace.daffodilvarsity.edu.bd:8080 Internet Source	<b>2%</b>
<b>3</b>	www.tutorialspoint.com Internet Source	<b>2%</b>
<b>4</b>	enterprise.zte.com.cn Internet Source	<b>1%</b>
<b>5</b>	Submitted to Engineers Australia Student Paper	<b>&lt;1%</b>
<b>6</b>	en.wikipedia.org Internet Source	<b>&lt;1%</b>
<b>7</b>	Submitted to Universiti Kebangsaan Malaysia Student Paper	<b>&lt;1%</b>
<b>8</b>	sparkmarket.ru Internet Source	<b>&lt;1%</b>
<b>9</b>	worldwidescience.org Internet Source	<b>&lt;1%</b>

---

<b>10</b>	<b>www.nstec.com</b> Internet Source	<1 %
<b>11</b>	<b>Submitted to University of Ruhuna Matara</b> Student Paper	<1 %
<b>12</b>	<b>www.studymode.com</b> Internet Source	<1 %
<b>13</b>	<b>Submitted to Universiti Teknologi Malaysia</b> Student Paper	<1 %

---

Exclude quotes  On

Exclude matches  Off

Exclude bibliography  On